

# LYNK II

(950-0025)

## NOARK MANUAL

---

READ AND SAVE THESE INSTRUCTIONS

- INTRODUCTION ..... 3**
- 1. AUDIENCE, WARNINGS, MESSAGES, GENERAL SAFETY, PERSONAL PROTECTIVE EQUIPMENT ... 3**
  - 1.1 Audience. .... 3
  - 1.2 Warning, Caution, Notice, and Note Messages. .... 3
  - 1.3 General Warnings ..... 4
  - 1.4 Safe Handling Procedures. .... 4
  - 1.5 Personal Protective Equipment. .... 5
- 2. DOCUMENTATION..... 5**
- 3. OVERVIEW ..... 6**
  - 3.1 System Overview. .... 6
  - 3.2 Compatibility ..... 7
  - 3.3 Minimum Battery System Capacity ..... 8
- 4. LYNK II CAN HARDWARE TERMINATION AND CAN OUT PIN CONFIGURATION..... 9**
  - 4.1 LYNK II CAN Termination ..... 9
  - 4.2 LYNK II CAN Out - RJ45 PIN Assignments for NOARK Inverters ..... 10
- 5. INSTALLING AND CONNECTING LYNK II TO THE NOARK NETWORK ..... 10**
  - 5.1 Networking Discover Lithium Batteries with LYNK II ..... 10
  - 5.2 Connecting LYNK II to the NOARK Network. .... 12
- 6. ENABLING LYNK II TO COMMUNICATE WITH NOARK DEVICES ..... 13**
  - 6.1 NOARK Managed (Closed-Loop) Configuration ..... 13
- APPENDIX..... 17**
  - A.1 NOARK Self-Managed (Open-Loop) Configuration. .... 17

# INTRODUCTION

This Application Note provides information about integrating LYNK and AEBus network-enabled Discover Lithium Batteries using the LYNK II Communication Gateway with NOARK power conversion devices.

## 1. AUDIENCE, WARNINGS, MESSAGES, GENERAL SAFETY, PERSONAL PROTECTIVE EQUIPMENT

### 1.1 Audience

Configuration, installations, service, and operating tasks should only be performed by qualified personnel in consultation with local authorities having jurisdiction and authorized dealers. Qualified personnel should have training, knowledge, and experience in the:

- Installation of electrical equipment
- Application of electrical codes, safety, and installation standards
- Analysis and reduction of hazards involved in performing electrical work
- Installation and configuration of batteries
- Installation and configuration of systems activated by relays

### 1.2 Warning, Caution, Notice, and Note Messages

Messages in this manual are formatted according to this structure.



Additional information concerning important procedures and features of the product. Read all the instructions before installation, operation, and maintenance.



Important information regarding hazardous conditions.

#### **⚠ WARNING**

Important information regarding hazardous conditions that may result in personal injury or death.

#### **⚠ CAUTION**

Important information regarding hazardous conditions that may result in personal injury.

#### **NOTICE**

Important information regarding conditions that may damage the equipment but not result in personal injury.

#### **NOTE**

Ad hoc information concerning important procedures and features unrelated to personal injury or equipment damage.

### 1.3 General Warnings

#### WARNING

##### **ELECTRIC SHOCK AND FIRE HAZARD**

- This equipment must only be installed as specified.
- Do not disassemble or modify the battery.
- If the battery case has been damaged, do not touch exposed contents.
- There are no user-serviceable parts inside.

**Failure to follow these instructions may result in death or serious injury.**

#### WARNING

##### **ELECTRIC SHOCK AND FIRE HAZARD**

Do not lay tools or other metal parts on the battery or across the terminals.

**Failure to follow these instructions may result in death or serious injury.**

#### CAUTION

##### **ELECTRIC SHOCK**

- Do not touch the energized surfaces of any electrical component in the battery system.
- Before servicing the battery, follow all procedures to fully de-energize the battery system.
- Follow the “Safe Handling Procedures” below when working with the battery.

**Failure to follow these instructions may result in injury.**

### 1.4 Safe Handling Procedures

Before using the battery and any power electronics, read all instructions and cautionary markings on all components and appropriate sections of their manuals.

- Use personal protective equipment when working with batteries.
- Do not dispose of the battery in a fire.
- Promptly dispose of or recycle used batteries following local regulations.
- Do not disassemble, open, crush, bend, deform, puncture, or shred.
- Do not modify, re-manufacture, or attempt to insert foreign objects into the battery, immerse or expose the battery to water or other liquids, fire, explosion, or other hazards. If the user suspects damage to the battery module due to water, heat, or other reason, take it to a service center for inspection.
- Only use the battery for the system for which it is specified.
- Do not lift or carry the battery while in operation.
- When lifting a heavy battery, follow the appropriate standards.
- Only lift, move, or mount following local regulations.
- Take care when handling battery terminals and cabling.
- Only use the battery with a charging system that meets specifications. Using a battery or charger that does not meet specifications may present a risk of fire, explosion, leakage, or other hazards.

- Do not short-circuit a battery or allow metallic conductive objects to contact battery terminals.
- Replace the battery only with another battery that has been qualified for the system. Using an unqualified battery may present a risk of fire, explosion, leakage, or other hazards.
- Do not drop the device or battery. If the device or battery is dropped, especially on a hard surface, and the user suspects damage, take it to a service center for inspection.

## 1.5 Personal Protective Equipment

When handling or working near a battery:

- Use Personal Protective Equipment, including clothing, glasses, insulated gloves, and boots.
- Do not wear rings, watches, bracelets, or necklaces.

## 2. DOCUMENTATION

This Application Note provides information about integrating LYNK and AEBus network-enabled Discover Lithium Batteries using the LYNK II Communication Gateway with NOARK power conversion devices in a managed (closed-loop) configuration.

Before installation and configuration, consult the relevant product documentation, including Manuals, Application Notes, Installation and Configuration Guides.

### NOARK Documentation

- NOARK Hybrid Inverter User Manual
- NOARK Dual-MPPT Single Phase Hybrid Inverter 3-6 kW datasheet
- NOARK Dual-MPPT Single Phase Hybrid Inverter 7.6-8 kW datasheet
- NOARK Three Phase Hybrid Inverter 5-12 kW datasheet

Visit <https://noark-electric.eu/en> for the most recent version of published documents.

### Discover Energy Systems Documentation

- [AES 42-48-6650 LiFePO4 Installation and Operation Manual](#) (805-0065)
- [AES LiFePO4 datasheet](#) (808-0004)
- [AES RACKMOUNT Installation and Operation Manual](#) (805-0043)
- [AES RACKMOUNT datasheet](#) (808-0039)
- [LYNK II Installation and Operation Manual](#) (805-0033)

Visit <https://www.discoverlithium.com> for the most recent version of published documents.

### 3. OVERVIEW

This manual provides general settings and is not a comprehensive guide to the programming and configuration of a specific installation. An installation may have unique conditions or use cases that require modification or adaptations of values. Installers must be capable of reviewing and adapting to the specifics of an installation and its specific use case and optimizing settings where needed.

The key steps required to install and configure the LYNK II Communication Gateway with compatible Discover Lithium batteries and power conversion equipment are as follows:

- Review and confirm equipment compatibility and correct sizing.
- Configure the LYNK II CAN out pins to match the CAN in pins of the power conversion equipment.
- Mount the LYNK II, connect the Discover battery communication network to either the LYNK Port or AEBus Port, and then connect the CAN Out Port to the power conversion equipment's communication network.
- Terminate all networks correctly.
- Set the LYNK II using LYNK ACCESS software to the correct protocol to enable managed (closed-loop) communication between the Discover batteries and the power conversion equipment.
- Set up the managed (closed-loop) configuration parameters on the power conversion equipment.
- Set up user preferences and enable the use case using the power conversion control system.

#### 3.1 System Overview

The LYNK II Communication Gateway unlocks the full potential of a Discover Lithium battery by enabling the internal Battery Management System (BMS) to provide real-time data in a managed (closed-loop) configuration to other devices. Managed (closed-loop) communication allows inverter-chargers and solar charge controller systems to optimize their control over the charging process in solar applications. LYNK II also enables the remote monitoring of Discover Lithium battery SOC and data logging of multiple sites using the data monitoring services offered by off-grid inverter systems.

Discover Lithium batteries must be set up to work with power conversion and monitoring devices in either a self-managed (open-loop) or managed (closed-loop) configuration.

Discover Lithium battery charge and discharge settings in a self-managed (open-loop) configuration are set up manually through the controller for the power conversion device at installation time. Refer to [A.1 NOARK Self-Managed \(Open-Loop\) Configuration](#).

In a managed (closed-loop) configuration, the BMS of the Discover Lithium battery sends the battery status over a network data connection with the power conversion device. Power conversion devices use the Discover Lithium battery BMS data to fine tune the output of their charger and deliver other functional controls based on battery voltage, temperature, and percent State-of-Charge.

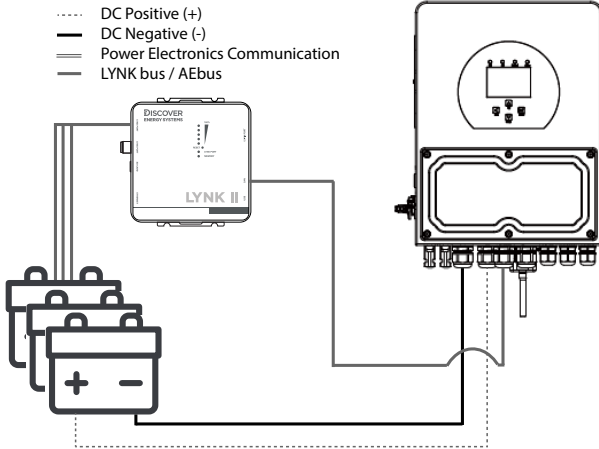

**Figure 1. System Overview**

## 3.2 Compatibility

### Discover Lithium Batteries

A Discover battery must have a compatible network port, such as a LYNK Port or AEBus Port, for communicating with a LYNK II device.

- AES LiFePO<sub>4</sub>: 42-48-6650
- AES RACKMOUNT: 48-48-5120, 48-48-5120-H

### NOARK Inverters

The LYNK II Communication Gateway is compatible with the following NOARK devices:

Single Phase	Three Phase
Ex9N-DH-3KS-AU	Ex9N-DH-5KT-AU
Ex9N-DH-3.6KS-AU	Ex9N-DH-6KT-AU
Ex9N-DH-5KS-AU	Ex9N-DH-8KT-AU
Ex9N-DH-6KS-AU	Ex9N-DH-10KT-AU
Ex9N-DH-7.6KS-AU	Ex9N-DH-12KT-AU
Ex9N-DH-8KS-AU	

### 3.3 Minimum Battery System Capacity

The Discover Lithium Battery and NOARK device automatically manage the battery charge and discharge rates. Using large solar arrays with battery banks that are too small can exceed the operating limits of the battery to charge and possibly lead to the BMS triggering over-current protection. Battery capacity must accept the maximum charge current of the system, or charging must be curtailed below the operating limit of the installed batteries. Derive this value by adding together the charge capacities of all inverter-chargers and solar charge controllers in the system. Additionally, battery peak capacity must support the surge requirements demanded by the load attached to the inverter-charger. Match all inverter-charger peak power values with the sum of all battery peak battery current values.

$$\text{Inverter Peak} = (\text{Inverter Surge Value}) / (\text{Inverter Efficiency}) / (48\text{V: Low Battery Cut-Off})$$

Single-Phase Models	Inverter Peak (10 seconds)	Max Continuous Charge	Max Continuous Discharge	AES LiFePO <sub>4</sub> 42-48-6650 Minimum per inverter <sup>(3)</sup>	AES RACKMOUNT 48-48-5120/48-48-5120-H Minimum per inverter <sup>(4)</sup>
Ex9N-DH-3KS-AU	129 A <sup>(1)</sup>	70 ADC	70 ADC	1	1
Ex9N-DH-3.6KS-AU	155 A <sup>(1)</sup>	90 ADC	90 ADC	1	1
Ex9N-DH-5KS-AU	215 A <sup>(1)</sup>	120 ADC	120 ADC	1	2
Ex9N-DH-6KS-AU	258 A <sup>(1)</sup>	135 ADC	135 ADC	2	2
Ex9N-DH-7.6KS-AU	326 A <sup>(2)</sup>	190 ADC	190 ADC	2	2
Ex9N-DH-8KS-AU	344 A <sup>(2)</sup>	190 ADC	190 ADC	2	2

<sup>(1)</sup> Calculated based on the surge power and max Euro efficiency as published in NOARK Hybrid Inverter User Manual (Ex9N-DH-3KS1-AU/ Ex9N-DH-3KS-AU/ Ex9N-DH-3.6KS-AU/ Ex9N-DH-5KS-AU/ Ex9N-DH-6KS-AU).

<sup>(2)</sup> Calculated based on the surge power and max efficiency as published in NOARK Dual-MPPT Single Phase Hybrid Inverter 7.6 to 8 kW datasheet.

<sup>(3)</sup> Discover AES LiFePO<sub>4</sub> 42-48-6650 Battery, Peak Discharge Current: 300 A (3 seconds), 130 A DC Continuous Charge/ Discharge, as published in Discover LiFePO<sub>4</sub> 42-48-6650 Installation and Operation Manual (805-0065 Rev A).

<sup>(4)</sup> Discover AES RACKMOUNT 48-48-5120/48-48-5120-H Battery, Peak Power: 218 A RMS (3 seconds), 95 A DC Continuous Charge/Discharge, as published in Discover AES RACKMOUNT Installation and Operation Manual (805-0043 Rev E).



**Inverter Peak = (Inverter Surge Value) / (Inverter Efficiency) / (48V: Low Battery Cut-Off)**

Three-Phase Models	Inverter Peak (10 seconds) <sup>(1)</sup>	Max Continuous Charge	Max Continuous Discharge	AES LiFePO <sub>4</sub> 42-48-6650 Minimum per inverter <sup>(2)</sup>	AES RACKMOUNT 48-48-5120/48-48-5120-H Minimum per inverter <sup>(3)</sup>
Ex9N-DH-5KT-AU	215 A	120 ADC	120 ADC	1	2
Ex9N-DH-6KT-AU	258 A	150 ADC	150 ADC	2	2
Ex9N-DH-8KT-AU	344 A	190 ADC	190 ADC	2	2
Ex9N-DH-10KT-AU	429 A	210 ADC	210 ADC	2	3
Ex9N-DH-12KT-AU	515 A	240 ADC	240 ADC	2	3

<sup>(1)</sup> Calculated based on the surge power and max Euro efficiency as published in NOARK Three Phase Hybrid Inverter 5 to 12 kW datasheet.  
<sup>(2)</sup> Discover AES LiFePO<sub>4</sub> 42-48-6650 Battery, Peak Discharge Current: 300 A (3 seconds), 130 A DC Continuous Charge/Discharge, as published in Discover LiFePO<sub>4</sub> 42-48-6650 Installation and Operation Manual (805-0065 Rev A).  
<sup>(3)</sup> Discover AES RACKMOUNT 48-48-5120/48-48-5120-H Battery, Peak Power: 218 A RMS (3 seconds), 95 A DC Continuous Charge/Discharge, as published in Discover AES RACKMOUNT Installation and Operation Manual (805-0043 Rev E).

## 4. LYNK II CAN HARDWARE TERMINATION AND CAN OUT PIN CONFIGURATION

### 4.1 LYNK II CAN Termination

<b>NOTE</b>
Disconnect power and all connections to LYNK II before attempting to configure header jumpers.

Jumpers are used to configure termination for AEBus and LYNK Network, and the CAN Out pin assignments. Follow the [LYNK II Installation and Operation Manual](#) (805-0033) to learn how to access and configure the header board with jumpers.

Detailed pin configurations are included in the LYNK II User Manual but are repeated here for convenience.

<b>NOTE</b>
LYNK II terminates the AEBus and LYNK Network by default. Do not remove the termination jumper inside LYNK II unless instructed to do so by Discover Energy Systems.

## 4.2 LYNK II CAN Out - RJ45 PIN Assignments for NOARK Inverters

CAN signals (CAN H, CAN L, CAN GND) can be assigned to any pin of the RJ45 connector on the LYNK II by adjusting the jumpers on the header board.

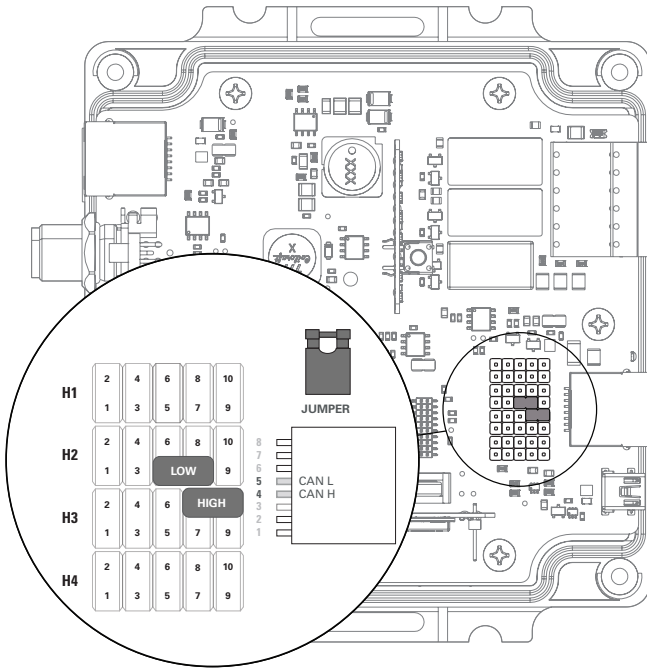

Figure 2. CAN pin assignment for NOARK communication

CAN Out	Header Jumper	RJ45 Pin
CAN L	H2 - 5 - 7	5
CAN H	H3 - 8 - 10	4
CAN GND	N/A	N/A

## 5. INSTALLING AND CONNECTING LYNK II TO THE NOARK NETWORK

### 5.1 Networking Discover Lithium Batteries with LYNK II

#### NOTE

- Turn OFF all devices before connecting cables.
- Do not plug an AEBus RJ45 network cable or terminator into the 10/100 Ethernet port of the LYNK II.
- Do not connect a CAT5 or higher cable from the AEBus, LYNK, or Ethernet ports of the LYNK II to a WAN or MODEM port of a network router.
- Mixing the LYNK Network with other networks may result in equipment malfunction and damage.

## NOTE

Unless Discover Energy Systems specifies, power electronics must not be connected directly to the LYNK or AEBus network.

Refer to the [LYNK II Installation and Operation Manual](#) (805-0033) for detailed instructions on network layouts, connections, and terminations for compatible Discover Lithium battery models. Some key reminders are provided in this manual.

- At least one battery must be connected to the LYNK Port or AEBus Port on LYNK II.
- A network of batteries will communicate as one battery.
- No more than one network of batteries may be connected to LYNK II.
- Network termination is required for the system's proper functioning - note some batteries and devices may auto-terminate.
- LYNK II requires power. There are three possible sources: a 13-90VDC power supply, AEBus Port or LYNK Port-enabled Discover Lithium battery, or a USB device.
- Discover Lithium batteries must be set to ON to supply power and communicate data with LYNK II.

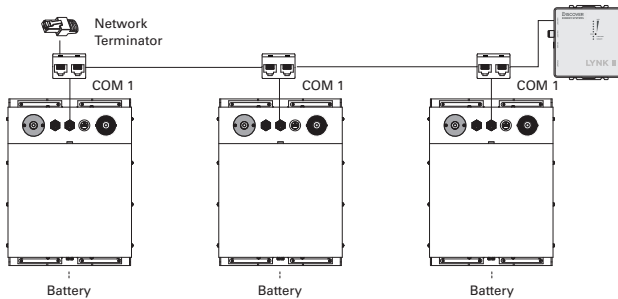

**Figure 3. AEBus Network Termination**

AES LiFePO<sub>4</sub> batteries are not internally terminated. The LYNK II communication gateway is internally terminated. When using LYNK II with an AEBus network, install a terminator at the end opposite LYNK II.

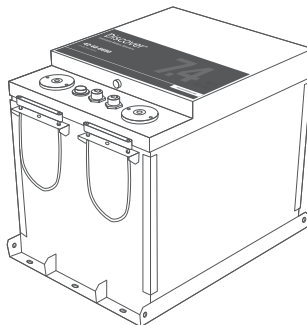
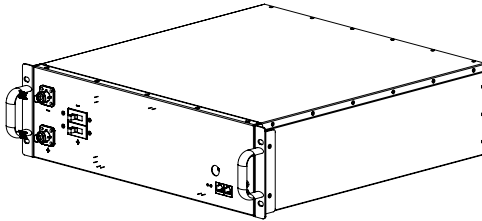

**Figure 4. AES LiFePO<sub>4</sub> Battery**

## NOTE

AES LiFePO<sub>4</sub> 48V batteries sold before Jan 1, 2020, will not supply power to LYNK II using the network cable connection. An external 13-90 VDC power source connected to the Phoenix 12-pin connector on LYNK II is REQUIRED for the AES LiFePO<sub>4</sub> batteries listed below.

- 42-48-6650 with a serial number before DET424820275xxxx



**Figure 5. AES RACKMOUNT Battery Module**

Both LYNK II and AES RACKMOUNT Battery Modules are internally terminated. No extra termination is required.

## 5.2 Connecting LYNK II to the NOARK Network

Before connecting LYNK II to the NOARK network, confirm that the CAN out pins on the LYNK II are configured correctly. Refer to [4. LYNK II CAN Hardware Termination and CAN Out PIN Configuration](#).

Insert one end of a CAT5 or higher communication cable into the LYNK II CAN out port and the other end into the correct CAN port of the NOARK inverter-charger.

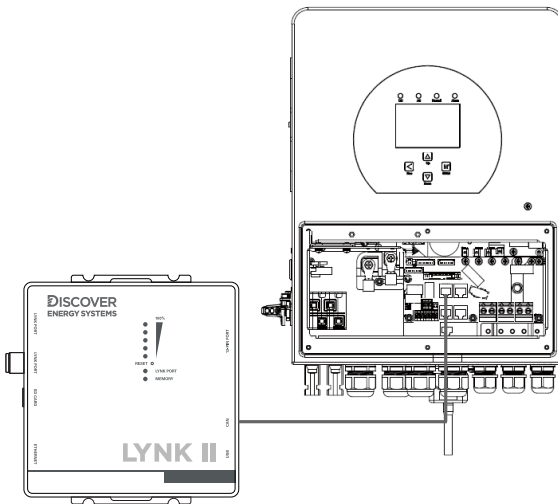

**Figure 6. NOARK CANopen Connection**

## 6. ENABLING LYNK II TO COMMUNICATE WITH NOARK DEVICES

When properly connected to a managed (closed-loop) network and set to use the NOARK protocol, LYNK II will transmit real-time parameters from the Discover Lithium battery, including voltage, current, temperature, state of charge, and fault conditions to a NOARK inverter-charger. LYNK II will also transmit charge voltage and current requests from the Discover Lithium battery to a NOARK inverter-charger.

LYNK ACCESS software for 64-bit Windows 10 / 11 is required to configure LYNK II settings for managed (closed-loop) CAN communication with NOARK inverter-chargers.

If there is a break in communication between the LYNK II and inverter-charger for more than ten seconds, the inverter-charger will safely stop operation, so long as the BMS Lithium option is selected and the BMS\_Err\_Stop parameter is enabled on the NOARK inverter-charger. The inverter-charger will display an F58 BMS Communication Fault if communication is lost. The NOARK inverter-charger will check every five minutes and resume managed (closed-loop) operation if communication is re-established. However, if communication cannot be reestablished, the NOARK inverter-charger will need to be manually converted to a self-managed (open-loop) configuration to resume operation. Refer to [A.1 NOARK Self-Managed \(Open-Loop\) Configuration](#).

### NOTE

- In a managed (closed-loop) configuration with the BMS Lithium Batt function enabled, the BMS\_Err\_Stop parameter must be enabled. If the BMS\_Err\_Stop parameter is not enabled, the NOARK inverter-charger will continue to operate based on the last communicated battery values. Depending on the mode of operation at the time of communication fault, and given enough time, the NOARK inverter-charger will eventually put the attached battery into an overcharged or fully discharged state. When that occurs, either situation will trigger the Discover Lithium Battery BMS to self-protect and disconnect the battery from the system.
- Neither Discover Lithium batteries nor LYNK II directly control NOARK relay functions, generator starting or other grid-interactive features. These functions are controlled through the programming of the NOARK inverter-charger.

### 6.1 NOARK Managed (Closed-Loop) Configuration

#### 6.1.1 Setting the LYNK II Communication Protocol for NOARK

Set the LYNK II communication protocol and configure the managed (closed-loop) setting on the NOARK inverter-charger.

#### LYNK II Protocol

1. Download the current version of LYNK ACCESS software from the Discover Energy Systems website to obtain the most up-to-date suite of available protocol configurations.

- Using a USB cable with a Type-B mini-plug, connect the 64-bit Windows 10 device running LYNK ACCESS software to the USB port on LYNK II. Ensure LYNK II is powered and connected to the correct NOARK COM port. Refer to [Figure 6. NOARK CANopen Connection](#).

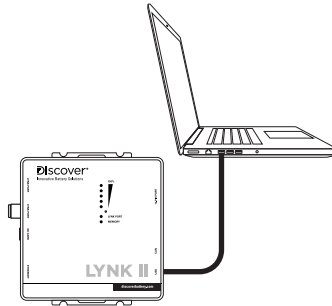

**Figure 7. Configuring LYNK II with LYNK ACCESS software**

- Open LYNK ACCESS. Options for configuration and settings are found by selecting the LYNK tab.
- Connect the LYNK II and open LYNK ACCESS. Ensure that you only have one LYNK device connected to the Computer.
- Open LYNK ACCESS and select the LYNK tab. Select the blue gear icon in the upper right area of the CAN Settings tile.
- Select the pre-configured NOARK protocol to complete the managed (closed-loop) configuration for LYNK II. Click SAVE to confirm the configuration.

### NOTE

Saving configuration changes using LYNK ACCESS will automatically cause LYNK II to shut down and restart.

## 6.1.2 Setting Managed (Closed-Loop) Configuration on the NOARK Inverter-Charger

### NOTE

In a managed (closed-loop) configuration with the BMS Lithium Batt function enabled, the BMS\_Err\_Stop parameter must be enabled. If the BMS\_Err\_Stop parameter function is not enabled, in the event of a communication error, the NOARK inverter-charger will continue to operate based on the last communicated battery values. Depending on the mode of operation at the time of communication fault and given enough time, the NOARK inverter-charger will eventually put the attached battery into an overcharged or fully discharged state. When that occurs, either situation will trigger the Discover Lithium Battery BMS to self-protect and disconnect the battery from the system.

After selecting the NOARK communication protocol for the LYNK II, complete the managed (closed-loop) configuration on the NOARK inverter-charger. Ensure the Discover Lithium Batteries are networked with LYNK II and that the LYNK II is connected to the NOARK CAN port.

If necessary, first configure NOARK inverter-chargers to operate in parallel by establishing the inverter-charger master/slave relationships and phase designations before setting the parameters for battery operation. Configuring the master inverter-charger will cascade parameters and settings to the slave inverter-chargers.

### Managed (Closed-loop) Configuration

Refer to the latest Discover Energy Systems documentation for battery values and the latest NOARK documentation for menu navigation and details on the setup procedure.

1. Set the Discover Lithium batteries to ON and set the inverter-charger to ON.
2. Using the touch screen and keypad on the inverter, navigate to Main Screen > System Setup > Battery Setting.
3. Specify the battery settings according to the instructions in the tables that follow.
4. Touch the Up and Down arrows to scroll through screens. Touch the check mark button to save changes.
5. Exit and restart the inverter-charger.

<b>NOTE</b>
If using multiple inverter-chargers, configure NOARK inverter-chargers to operate in parallel before setting the battery operation parameters.

### Main Screen > System Setup > Battery Setting

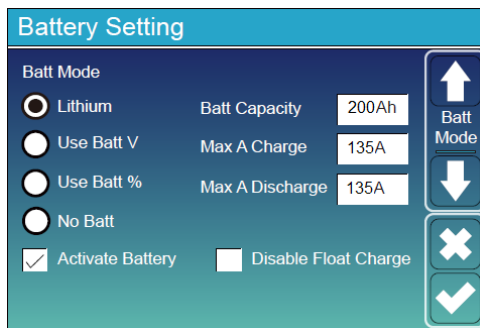

**Figure 8. Battery Setting - Managed (Closed-Loop) Charge Settings**

Touch the Up and Down arrows to scroll through screens. Touch the check mark button to save changes, X to cancel. Ignore data displayed in gray boxes.

<b>Battery Setting (page 1)</b>	
Batt Mode	
Lithium <sup>(1)</sup>	Select the Lithium option to use the battery BMS.
Use Batt V	
Use Batt %	
No Battery	
Activate Battery	Select this check box.

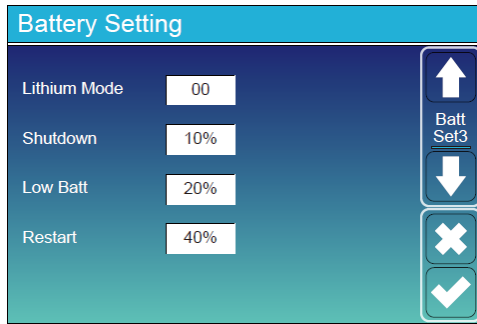
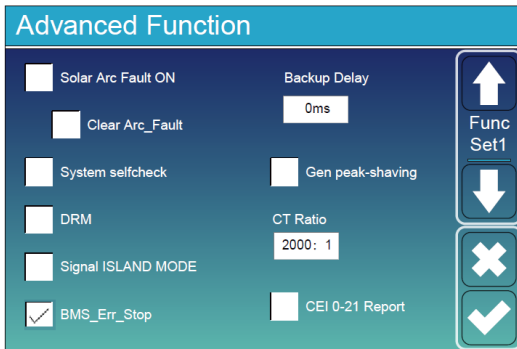

**Figure 9. Battery Setting - Managed (Closed-Loop) Charge Settings**

Touch the Up and Down arrows to scroll through screens. Touch the check mark button to save changes, X to cancel. Ignore data displayed in gray boxes.

Battery Setting (page 3)	
Lithium Mode	Set this value to 00.
Shutdown	Adjust values to support the use case or keep the original self-managed (open-loop) values.
Low Batt	
Restart	

**Main Screen > System Setup > Advanced Function**



**Figure 10. Advanced Function - Managed (Closed-Loop) Setting**

Touch the Up and Down arrows to scroll through screens. Touch the check mark button to save changes, X to cancel. Ignore data displayed in gray boxes.

Advanced Function	
BMS_Err_Stop	<p>Select this check box to cause the inverter-charger to stop operating if there is a communication error.</p> <p>If the BMS_Err_Stop check box is cleared, despite a communication error, the inverter-charger will continue to operate using the last communicated battery values which will eventually cause the batteries to invoke protection.</p>



# APPENDIX

## A.1 NOARK Self-Managed (Open-Loop) Configuration

The NOARK inverter-charger will need to be manually converted to a self-managed (open-loop) configuration if managed (closed-loop) communication cannot be established. Refer to the latest Discover Lithium battery documentation for battery values and the latest NOARK documentation for details on menu navigation and the setup procedure.

1. Set the Discover Lithium batteries to ON and set the inverter-charger to ON.
2. Using the touch screen and keypad on the inverter, navigate to Main Screen > System Setup > Battery Setting.
3. Specify the battery settings according to the instructions in the tables that follow. Touch the Up and Down arrows to scroll through screens.
4. Touch the check mark button to save changes.
5. Exit and restart the inverter-charger.

### NOTE

If using multiple inverter-chargers, configure NOARK inverter-chargers to operate in parallel before setting the parameters for battery operation.

#### A.1.1 Self-Managed (Open-Loop) — Battery Setting

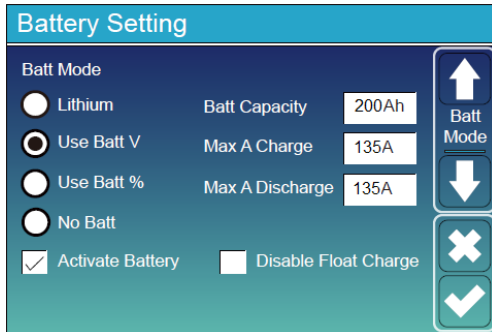

**Figure 11. Battery Setting - Self-Managed (Open-Loop) Charge Settings**

All values and parameters assume an operating temperature of 25 °C.

Touch the Up and Down arrows to scroll through screens. Touch the check mark button to save changes, X to cancel. Ignore data displayed in gray boxes.

Battery Setting (page 1)	
Batt Mode	
Lithium <sup>(1)</sup>	Select the Use Batt V option to use battery voltage for all the settings.
Use Batt V	
Use Batt %	
No Battery	

<b>Battery Setting (page 1)</b>	
Activate Battery	Select this check box.
Batt Capacity	Set to the number of Discover Lithium batteries x Ah capacity of each. For example, set to 200 Ah (2 x 100 Ah) for two AES RACKMOUNT 48-48-5120 batteries.
Max A Charge	<p>For a single inverter, set to the smaller value between the inverter's maximum charge rate or the quantity of attached batteries multiplied by the battery's maximum charge rating.</p> <p>For example:</p> <p>Single phase system with Ex9N-DH-6KS-AU inverter and two AES RACKMOUNT 48-48-5120 batteries:</p> <ul style="list-style-type: none"> <li>• Set the Ex9N-DH-6KS-AU inverter to the lesser of the inverter's maximum charge rate of 135 A, or 190 A for two AES RACKMOUNT 48-48-5120 batteries that are each rated at a maximum charge rating of 95 A (<math>2 \times 95 \text{ A} = 190 \text{ A}</math>).</li> </ul> <p>Three-phase system with three Ex9N-DH-6KT-AU inverters and four AES RACKMOUNT 48-48-5120 batteries:</p> <ul style="list-style-type: none"> <li>• For a three-phase system, set to the smaller value between the master inverter's maximum charge rate or the quantity of attached batteries multiplied by the battery's maximum charge rating divided by the number of inverters. For example, set the Ex9N-DH-6KT-AU inverter to the lesser of the inverter's maximum charge rate of 150 A, or 126 A for four AES RACKMOUNT 48-48-5120 batteries that are each rated at a maximum charge rate of 95 A, and then divided by three inverters (<math>4 \times 95 \text{ A} \div 3 = 126.667 \text{ A}</math>).</li> </ul>
Max A Discharge	<p>For a single inverter, set to the smaller value between the inverter's maximum discharge rate or the quantity of attached batteries multiplied by the battery's maximum discharge rating. For example, set the Ex9N-DH-6KS-AU inverter to the lesser of the inverter's maximum discharge rate of 135 A, or 190 A for two AES RACKMOUNT 48-48-5120 batteries that are each rated at a maximum discharge rating of 95 A.</p> <p>For a three-phase system, set to the smaller value between the master inverter's maximum discharge rate or the quantity of attached batteries multiplied by the battery's maximum discharge rating divided by the number of inverters. For example, set the Ex9N-DH-6KT-AU inverter to the lesser of the inverter's maximum discharge rate of 150 A, or 126 A for four AES RACKMOUNT 48-48-5120 batteries that are each rated at a maximum discharge rate of 95 A and then divided by 3 inverters (<math>4 \times 95 \text{ A} \div 3 = 126.667 \text{ A}</math>).</p>

<sup>(1)</sup> To configure the self-managed (open-loop) parameters, do not select the Lithium parameter. Selecting the Lithium parameter enables the BMS for managed (closed-loop) communication.

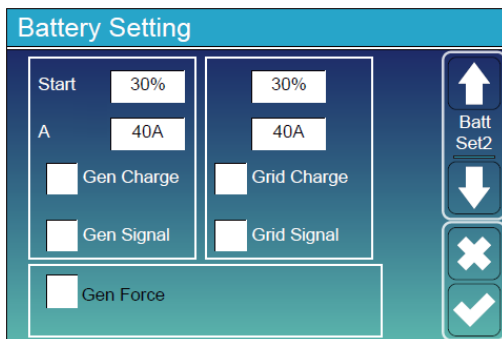

**Figure 12. Battery Setting - Generator / Grid Charge Settings**

Touch the Up and Down arrows to scroll through screens. Touch the check mark button to save changes, X to cancel. Ignore data displayed in gray boxes.

Battery Setting (page 2)	
Start (%)	Not required in a self-managed (open-loop) configuration.
A	Set to the same Amp value that was used for the maximum charge current. <sup>(1)</sup>
Gen Charge	Select this check box if charging the battery bank from an attached generator. <sup>(2)</sup>  Note: The Gen Input Breaker must be connected to the output of an AC generator for this work.
Gen Signal	Normally open relay that closes when the Gen Start signal state is active.
Gen Force	When the generator is connected, you can force the generator to start without meeting other conditions.
Grid Change	Select this check box if charging from the grid is desired. <sup>(3)</sup>  A Grid Input Breaker must be connected to input from the grid for this to work.
Grid Signal	Clear the check box.

<sup>(1)</sup> If need be, this value is used to curtail the maximum current output of the charger.

<sup>(2)</sup> The options in the left column are for Generator Charge AutoStart values. Refer to Noark documentation for information on using the Generator AutoStart function.

<sup>(3)</sup> The options in the right column are for Grid Charge values.

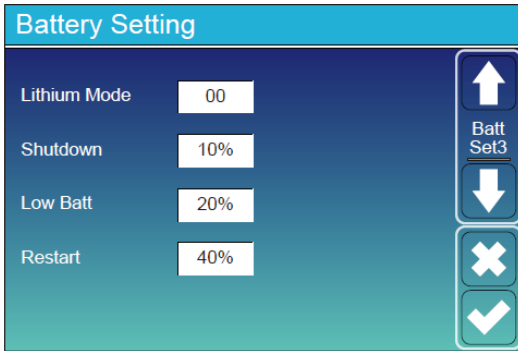

**Figure 13. Battery Setting - Inverter Shutdown/Restart Settings**

Touch the Up and Down arrows to scroll through screens. Touch the check mark button to save changes, X to cancel. Ignore data displayed in gray boxes.

<b>Battery Setting (page 3)</b>	
Lithium Mode	This property is not applicable in a self-managed (open-loop) configuration.
Shutdown	Turns off the inverter when the battery reaches this SOC.
Low Batt	Inverter outputs a warning when the battery reaches this SOC.
Restart	Inverter AC output continues when the battery reaches this SOC.

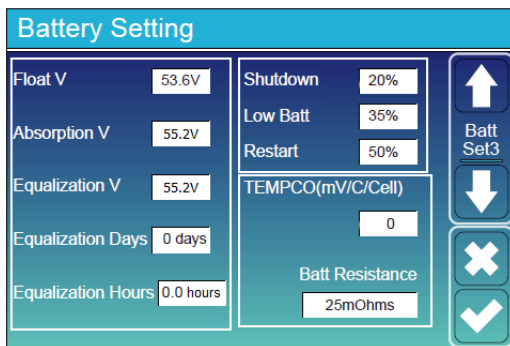

**Figure 14. Battery Setting - Self-managed (Open-loop) Battery Settings**

Touch the Up and Down arrows to scroll through screens. Touch the check mark button to save changes, X to cancel. Ignore data displayed in gray boxes.

Battery Setting (page 3)	AES LiFePO4 42-48-6650	AES RACKMOUNT 48-48-5120 / 48-48-5120-H
Float V	53.6 V	53.6 V
Absorption V	55.2 V	55.2 V
Equalization V	Do not equalize Discover Lithium batteries	
Equalization Days		
Equalization Hours		
Shutdown (%)	Turns off the inverter when the battery reaches the specified SOC.	
Low Batt (%)	Inverter outputs a warning when the battery reaches the specified SOC.	
Restart (%)	Inverter AC output continues when the battery reaches the specified SOC.	
TEMPCO (mv/C/Cell)	Set to 0 mv/C/Cell. <sup>(1)</sup>	
Batt Resistance	Keep the default value of 25 mOhms.	

<sup>(1)</sup> Discover Lithium batteries do not require temperature compensation. Setting TEMPCO to 0 mv/C/Cell disables inverter controlled temperature compensation.