

LYNK II

(950-0025)

INSTALLATION AND OPERATION MANUAL

INTRODUCTION	3
1.0 AUDIENCE, MESSAGES, WARNINGS, GENERAL SAFETY, PERSONAL PROTECTIVE EQUIPMENT	3
1.1 Audience.....	3
1.2 Warning, Caution, Notice, and Note Messages.....	3
1.3 General Warnings.....	4
1.4 Safe Handling Procedures.....	4
1.5 Personal Protective Equipment.....	5
2.0 DOCUMENTATION	5
3.0 ABOUT LYNK II	6
3.1 Overview	6
3.2 Compatible Batteries and Devices.....	6
3.3 Compatible Communication Protocols.....	7
3.4 Firmware Revision	7
4.0 ITEMS SHIPPED IN THE BOX	8
5.0 DESIGN AND FEATURES	8
5.1 Reset Button Operation.....	9
5.2 LED Indicators	9
5.3 LYNK Port Pin Assignment	11
5.4 Pin Assignments for Phoenix 12-pin Connector	11
5.5 Power Sources for LYNK II	12
6.0 CAN HARDWARE TERMINATION AND CAN OUT PIN CONFIGURATIONS .	13
6.1 Access to Configuration Header Boards and Jumpers	13
6.2 CAN Termination	14
6.3 CAN Out - RJ45 Header Assignments.....	16
7.0 INSTALLATION	23
7.1 Mounting LYNK II	23
7.2 Installing the External Power Source	23
7.3 LYNK Network Communication Cables.....	23
7.4 Maximum Number of Batteries on the LYNK Network.....	28
7.5 Verification of the LYNK Network	28
8.0 RELAY HARDWARE INSTALLATION	29
9.0 ETHERNET HARDWARE INSTALLATION AND LAYOUT	30
10.0 CONNECTING TO LYNK ACCESS	30
11.0 CONFIGURING THE CAN COMMUNICATION WITH LYNK ACCESS	32
12.0 CONFIGURING ETHERNET SETTINGS WITH LYNK ACCESS	32
13.0 CONFIGURING RELAYS WITH LYNK ACCESS	32
13.1 Relay Configuration - Relay Profile.....	33
13.2 Relay Configuration - Trigger Settings.....	34
13.3 Relay Configuration - Alarm Trigger	35
13.4 Relay Configuration - Operation States.....	36
14.0 TROUBLESHOOTING THE BATTERY WITH LYNK ACCESS	37
14.1 Generating a Battery Diagnostic Report.....	37
14.2 Exporting Battery Data Logs	37
15.0 UPDATING LYNK II FIRMWARE WITH LYNK ACCESS	39
16.0 LYNK II SPECIFICATIONS	40

INTRODUCTION

This document provides information about the integration and setup of LYNK II with Discover Lithium battery systems.

1.0 AUDIENCE, MESSAGES, WARNINGS, GENERAL SAFETY, PERSONAL PROTECTIVE EQUIPMENT

1.1 Audience

Qualified personnel should perform configuration, installations, service, and operating tasks in consultation with local utilities and authorized dealers. Qualified personnel should have training, knowledge, and experience in the:

- Installation of electrical equipment
- Application of applicable installation codes
- Analyzation and reduction of hazards involved in performing electrical work
- Installation and configuration of batteries
- Installation and configuration of systems activated by relays.

1.2 Warning, Caution, Notice, and Note Messages

WARNING

Important information regarding hazardous conditions that may result in personal injury or death.

CAUTION

Important information regarding hazardous conditions that may result in personal injury.

NOTICE

Important information regarding conditions that may result in damage to the equipment but not personal injury.

NOTE

Ad hoc information concerning important procedures and battery features not related to personal injury or equipment damage.

1.3 General Warnings

WARNING

ELECTRIC SHOCK AND FIRE HAZARD

- A lithium battery must be installed as specified.
- Do not disassemble or modify the battery.
- If the battery case has been damaged, do not touch exposed contents.
- There are no user-serviceable parts inside.

Failure to follow these instructions may result in death or serious injury.

WARNING

ELECTRIC SHOCK AND FIRE HAZARD

Do not lay tools or other metal parts on top of the battery or across the terminals.

Failure to follow these instructions may result in death or serious injury.

CAUTION

ELECTRIC SHOCK

- Do not touch the energized surfaces of any electrical component in the battery system.
- Before servicing the battery, follow all procedures to fully de-energize the battery system.
- Follow the "Safe Handling Procedures" below when working with the battery.

Failure to follow these instructions may result in injury.

1.4 Safe Handling Procedures

Before using the battery and any power electronics, read all instructions and cautionary markings on all components and appropriate sections of their manuals.

- Use personal protective equipment when working with batteries.
- Do not dispose of the battery in a fire.
- Promptly dispose or recycle used batteries following local regulations.
- Do not disassemble, open, crush, bend, deform, puncture, or shred.
- Do not modify, re-manufacture, or attempt to insert foreign objects into the battery, immerse or expose the battery to water, other liquids, fire, explosion, or other hazards. If the user suspects damage to the battery due to water, heat, or other reason, take it to a service center for inspection.

- Only use the battery for the system for which it is specified.
- Do not lift or carry the battery while in operation.
- When lifting a heavy battery, follow the appropriate standards.
- Only lift, move, or mount following local regulations.
- Take care when handling battery terminals and cabling.
- Only use the battery with a charging system that has been qualified for the system. The use of an unqualified battery or charger may present a risk of fire, explosion, leakage, or other hazards.
- Do not short circuit a battery or allow metallic conductive objects to contact battery terminals.
- Replace the battery only with another battery that has been qualified for the system. Using an unqualified battery may present a risk of fire, explosion, leakage, or other hazards.
- Avoid dropping the device or battery. If the device or battery is dropped, especially on a hard surface, and the user suspects damage, take it to a service center for inspection.

1.5 Personal Protective Equipment

When handling or working near a battery:

- Use Personal Protective Equipment, including clothing, glasses, insulated gloves, and boots.
- Do not wear rings, watches, bracelets, or necklaces.

2.0 DOCUMENTATION

This document provides information about the integration and setup of LYNK II with Discover Lithium battery systems.

Before installation and configuration, consult the relevant product documentation, including Manuals, Application Notes, and Installation and Configuration Guides.

Discover Energy Systems Documentation

Visit <https://discoverlithium.com> for the most recent version of published documents, including Discover Lithium battery user manuals and application notes on using LYNK II with specific power conversion devices.

3.0 ABOUT LYNK II

3.1 Overview

LYNK II Communication Gateway unlocks the full potential of a Discover lithium battery by enabling the internal Battery Management System (BMS) to communicate closed-loop and in real-time State-of-Charge, voltage, temperature and status to compatible devices, such as solar or mobile inverter-chargers, on and off-board industrial chargers, displays, load centers, motor controls, PLCs, and telematics. Serial CAN and CANopen Interface Guides are also available for developers.

3.2 Compatible Batteries and Devices

A battery or device must have a compatible port such as a LYNK Port or AEBus Port to communicate with a LYNK II device.

LYNK Port

- AES PROFESSIONAL batteries: DLP-GC2-12V, DLP-GC2-24V, DLP-GC2-36V, DLP-GC2-48V
- AES RACKMOUNT batteries: 48-48-5120, 48-48-5120-H

AEBus Port

- AES LiFePO₄ batteries: 44-48-3000, 42-48-6650, 14-36-3000, 14-48-3000

3.3 Compatible Communication Protocols

LYNK ACCESS software for 64-bit Windows 10 / 11 is required to configure LYNK devices for communication with compatible external devices such as inverters, chargers and motor controllers. Download the current version of LYNK ACCESS software from the Discover Energy Systems website to obtain the most up-to-date suite of available device configurations. An interface guide for Discover Generic Serial CAN is available from the Discover Energy Systems website.

Available Communication Protocol Configurations (Partial List)
Victron Energy - GX and VE.CAN Inverter-chargers, solar MPPT Chargers and network devices
Morningstar - GenStar MPPT Controller
NOARK (pending) - Inverter-Chargers
SUNSYNK (pending) - Single-Phase and Three-Phase Inverter-Chargers
Studer Innotec - Xcom-Can Inverter-Chargers and network devices
SPE - GREEN Series Industrial Chargers
Sol-Ark - Outdoor and Indoor (Legacy) Inverter-Chargers
SMA - Sunny Island Inverter-Chargers
Schneider Electric - Xanbus Inverter-chargers and MPPT Chargers and network devices
RV-C - Various brands of inverter-charger and monitoring devices
CANopen - Refer to the Discover CANopen Interface Guide

3.4 Firmware Revision

This user manual is valid for LYNK II firmware version 1.70.0 or later. Use LYNK ACCESS software to view the firmware version of the LYNK II device.

4.0 ITEMS SHIPPED IN THE BOX

1	LYNK II device
1	USB cable (1 m, 3.28 ft) with a Type-B mini plug

5.0 DESIGN AND FEATURES

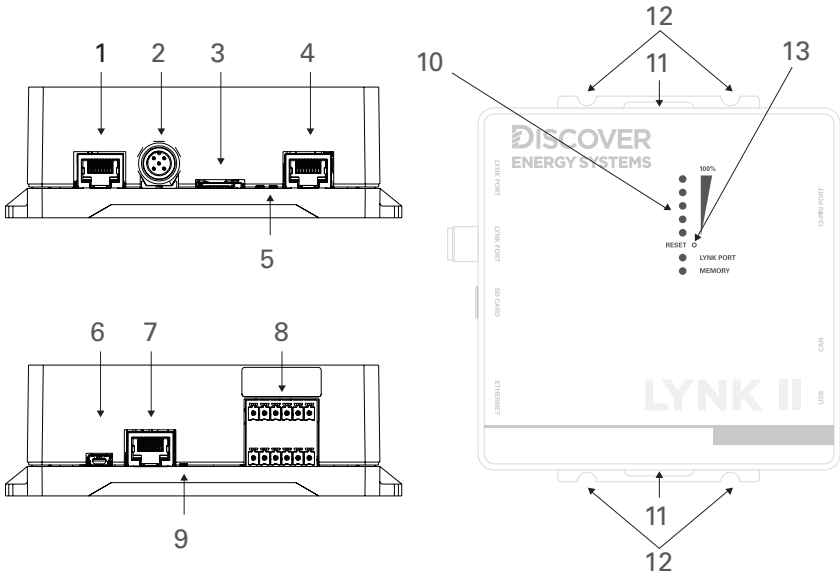

Figure 1. Ports, Buttons, LEDs, and Mounting Hold Downs

1	LYNK Port (AEBus)	RJ45 connection for LYNK AEBus Network communication input. Termination is configurable. (Terminated by Default)
2	LYNK Port	IEC M12 pin connector for LYNK Network communication input. Termination is configurable. (Terminated by Default)
3	Mini SD Card Slot	Used for extended battery data logging (128 GB) and updating battery and LYNK II device firmware.
4	Ethernet Port	Ethernet is reserved for future functionality.
5	Ethernet LED	
6	USB Mini Port	USB device port to connect with LYNK ACCESS software on Windows 10 / 11.
7	CAN Out	RJ45 connection used for CAN communications. Termination is configurable.
8	Phoenix 12-pin Connector	Connections are used by the relays, CAN Out, and supply power.
9	CAN Out LED	Indicates communication activity.

10	Status LEDs	Five LEDs indicate the State-of-Charge level. LYNK Port LED indicates the status and activity on the LYNK Port (RJ45 or 5-pin DIN connector). Memory LED indicates SD Card status.
11	Hold-Down Points	Hold-Down points for mounting the device with straps.
12	Mounting Slots	Slots for mounting the device with screws or bolts.
13	Reset Button	Pinhole button, press to reset LYNK II.

5.1 Reset Button Operation

Press and hold duration	LYNK II Operation
5 seconds or less.	LYNK II will restart.

5.2 LED Indicators

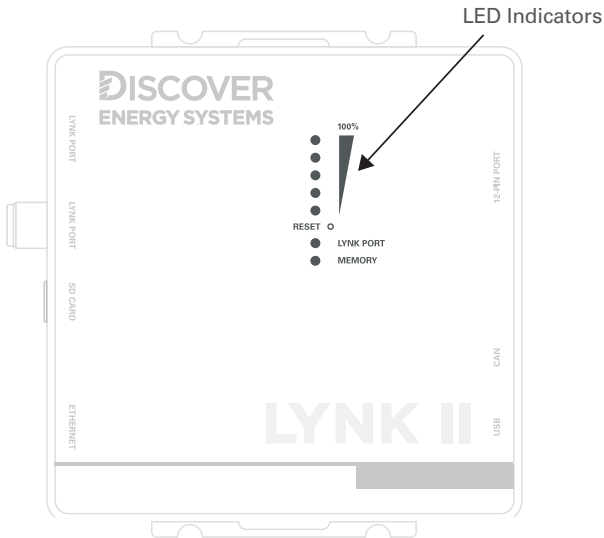

Figure 2. LYNK II LED Indicators

State-of-Charge LEDs	Indication
Segment - 5	Solid Green SOC is between 81-100%
Segment - 4	Solid Green SOC is between 61-80%

State-of-Charge LEDs	Indication
Segment - 3	Solid Green SOC is between 41-60%
Segment - 2	Solid Green SOC is between 21-40%
Segment - 1	Solid Green SOC is between 6-20%; Flashing Green SOC is 5% or below
Any LED Segment	Flashing once per second indicates the batteries are receiving a charge.
All LED Segments	Flashing two times per second indicates that one or more batteries are in protection mode.
Alternating Segment 1 through 5	This sequencing indicates that the LYNK II has power, but the batteries cannot communicate with LYNK II.

Data LEDs	Indication
LYNK Port LED	Flashes when a new battery is detected on one of the LYNK Ports. Solid when there is active communication on one of the LYNK Ports.
Memory LED	Off when no SD card is detected. They flash when data is transferred to or from the SD card. Solid when it is safe to remove the SD card.
Ethernet LED	Ethernet is reserved for future functionality.
CAN Out LED	Indicates that a CAN heartbeat message has been received in the proper protocol within the past 5 seconds.

5.3 LYNK Port Pin Assignment

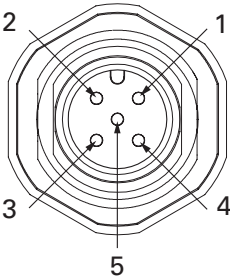

Figure 3. Pin Map M12 A-Code Circular Metric Connector

Pin	Description
1	Do Not Populate. Do not terminate to ground. Do not terminate to power. Do not terminate to CAN_L or CAN_H.
2	AEbus CAN L
3	AEbus CAN H
4	AEbus +12V
5	AEbus GND

5.4 Pin Assignments for Phoenix 12-pin Connector

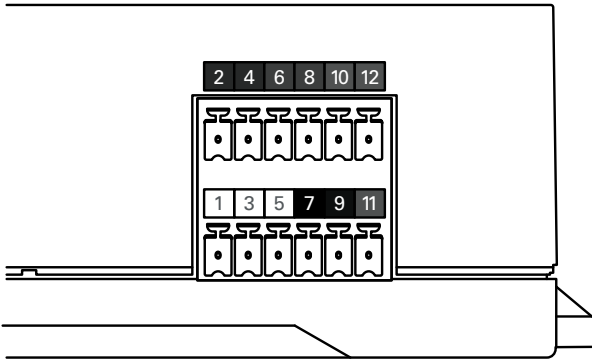

Figure 4. Pin Assignments for Phoenix 12-pin Connector

12-Pin Connector Layout					
2	4	6	8	10	12
RELAY 3 COM	RELAY 3 N/O	RELAY 2 N/O	RELAY 2 COM	RELAY 1 N/O	RELAY 1 COM
1	3	5	7	9	11
CAN HIGH	CAN LOW	CAN GND	POWER GND	POWER Vin (13-90V)	RELAY 1 N/C

5.5 Power Sources for LYNK II

LYNK II can utilize three power sources. All three power sources can be used alone or simultaneously. LYNK II will automatically use the highest priority source.

Priority	Source
1	13-90 VDC power supply input connected to pin 9 (Vin) and pin 7 (GND) of the 12-pin connector.
2	AEbus Port or LYNK Port of enabled batteries.
3	USB device (Relays will not function with USB as the only power supply)

NOTE

AES LiFePO₄, AES PROFESSIONAL, and AES RACKMOUNT batteries must be set to ON to supply power and communicate data with LYNK devices.

AES PROFESSIONAL and AES RACKMOUNT Batteries

AES PROFESSIONAL and AES RACKMOUNT batteries supply power to LYNK II using the network cable connected to the LYNK Port.

AES LiFePO₄ Batteries

AES LiFePO₄ batteries sold after Jan 1, 2020, supply power to LYNK II using the network cable connected to the AEbus Port.

NOTE

AES LiFePO₄ batteries sold before Jan 1, 2020, do not supply power to LYNK II using the network cable connection. An external 13-90 VDC power source connected to the Phoenix 12-pin connector on LYNK II is **REQUIRED** for the AES LiFePO₄ battery listed below.

- 42-48-6650 with a serial number before DET424820275xxxx

6.0 CAN HARDWARE TERMINATION AND CAN OUT PIN CONFIGURATIONS

Jumpers are used to configure termination for AEBus and CANbus, and the CAN Out pin assignments.

NOTICE

HAZARD OF EQUIPMENT DAMAGE

Disconnect power and all connections to LYNK II before attempting to configure header jumpers.

Failure to follow these instructions may result in damage to the equipment.

6.1 Access to Configuration Header Boards and Jumpers

To access the configuration header boards and jumpers:

1. Disconnect power and all connected cables and wires from LYNK II.
2. Loosen the keeper nut on the threaded barrel LYNK Port.
3. Unscrew the four case screws using a Phillips screwdriver.
4. Carefully separate the top from the bottom casing - Ensure the keeper nut, LYNK Port barrel, and four case screws do not become lost or drop onto exposed battery cables or terminals. Save all items to reseal the unit later.
5. Place the jumpers on the correct headers noted below to configure CAN Termination and CAN Out pins.
6. Reinstall the LYNK Port barrel with keeper nut on the outside, mate the top and bottom casing together and replace the four screws.

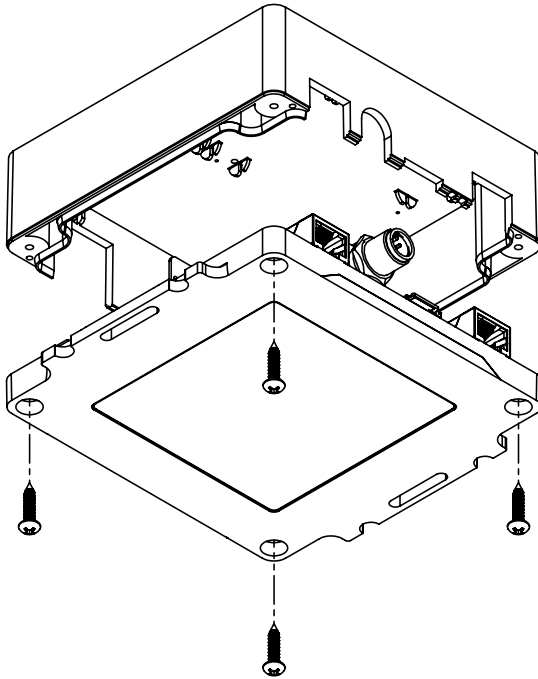

Figure 5. LYNK II Case Construction

6.2 CAN Termination

Jumpers are pre-positioned for the termination of AEBus and CANbus. Jumpers can be repositioned on the header board for different CAN Out RJ45 pin assignments.

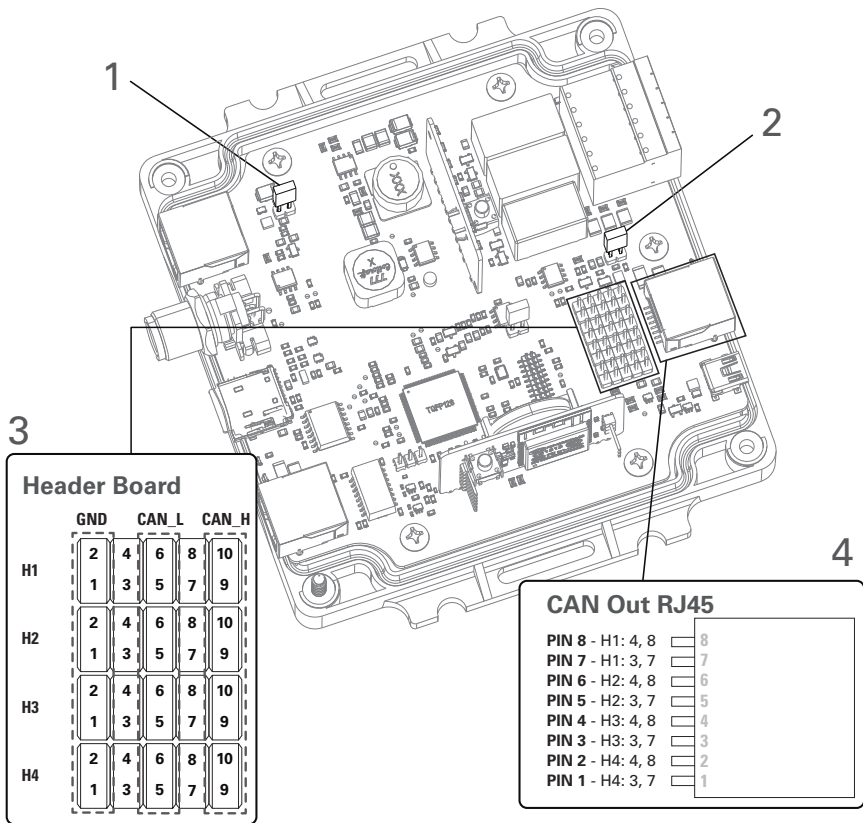

Figure 6. CAN Termination

1	AEBus Termination Header Board	A termination jumper is installed by default.
2	CAN Out Termination Header Board	A termination jumper is installed by default.
3	CAN Out RJ45 Configuration Header Board	Jumpers are used to customize the CAN GND, CAN L, and CAN H outputs on the RJ45 Port.
4	CAN Out RJ45 Pin Configuration	CAN Out RJ45 pins mapped to their Header Board positions.

NOTE

AEBus is terminated by default. Do not remove the AEBus termination jumper for LYNK II unless instructed to do so by Discover Energy Systems.

6.3 CAN Out - RJ45 Header Assignments

CAN signals (CAN H, CAN L, CAN GND) are assigned to any pin of the RJ45 connector by adjusting the jumpers on the header board.

6.3.1 Default pin assignments

CAN Out	Header Jumper	RJ45 Pin
CAN L	H2 - 5-7	5
CAN H	H3 - 8-10	4
CAN GND	H2 - 2-4	6

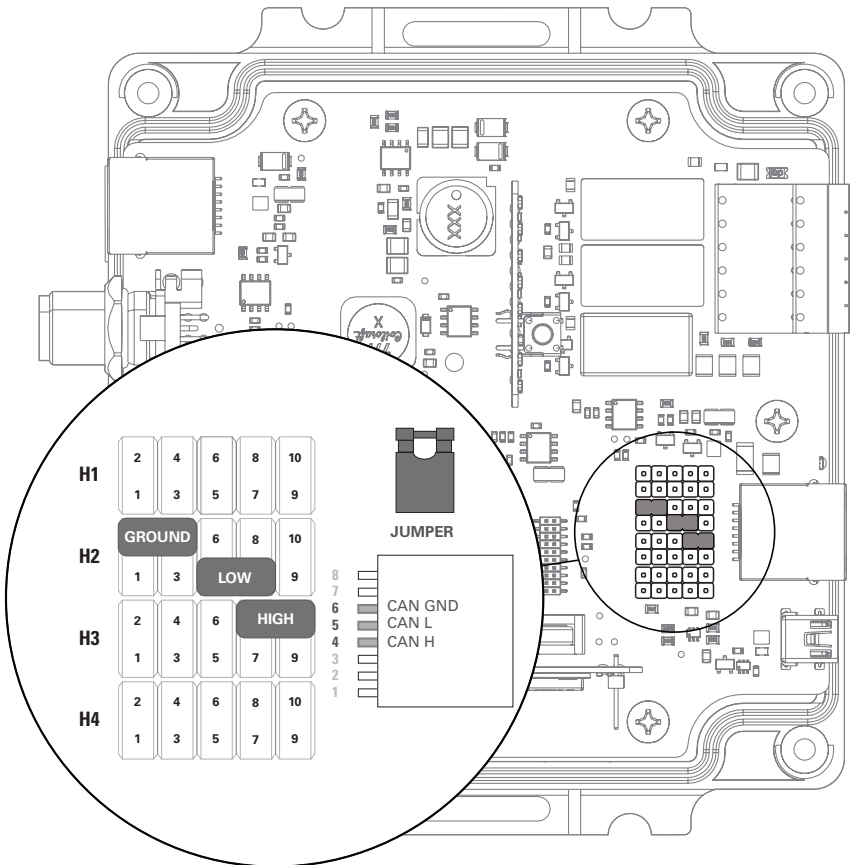

Figure 7. Default pin assignments

6.3.2 Previous default pin assignments (less than serial number DEzLKaa240010000)

CAN Out	Header Jumper	RJ45 Pin
CAN L	H2 - 5-7	5
CAN H	H3 - 8-10	4
CAN GND	H4 - 2-4	2

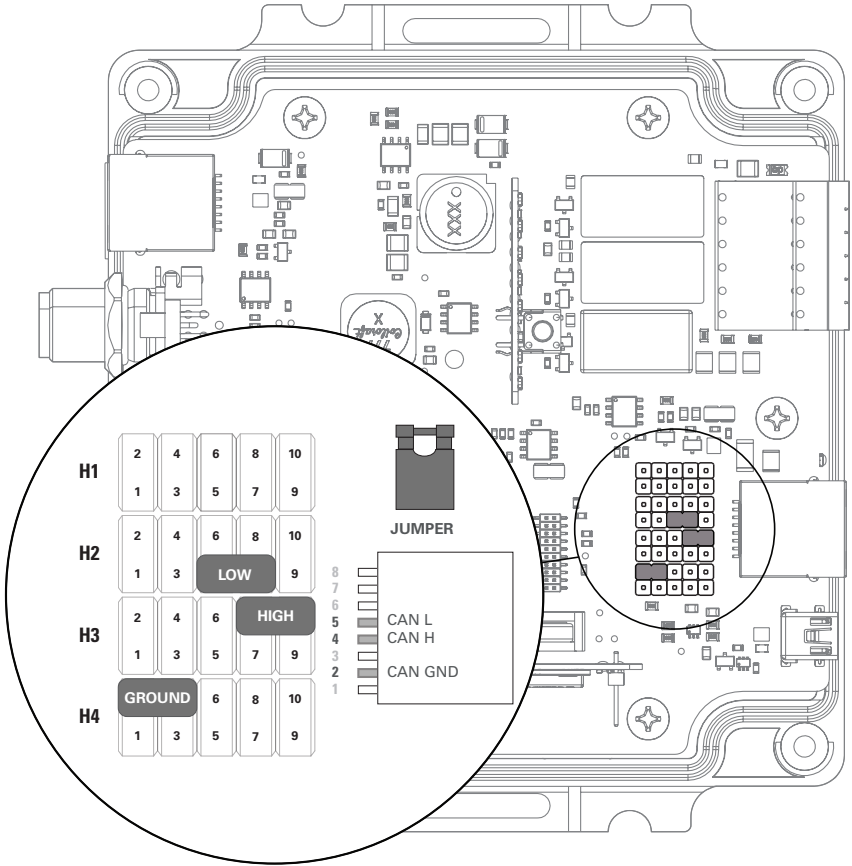

Figure 8. Previous default pin assignments

6.3.3 Common pin assignments:

Victron Energy - Color Control GX, Venus GX, VE.CAN Devices

Studer Innotec - Xcom-CAN Devices

CAN Out RJ45 Pin	Header Jumper	RJ45 Pin
CAN L	H1 - 6-8	8
CAN H	H1 - 7-9	7
CAN GND	H3 - 1-3	3

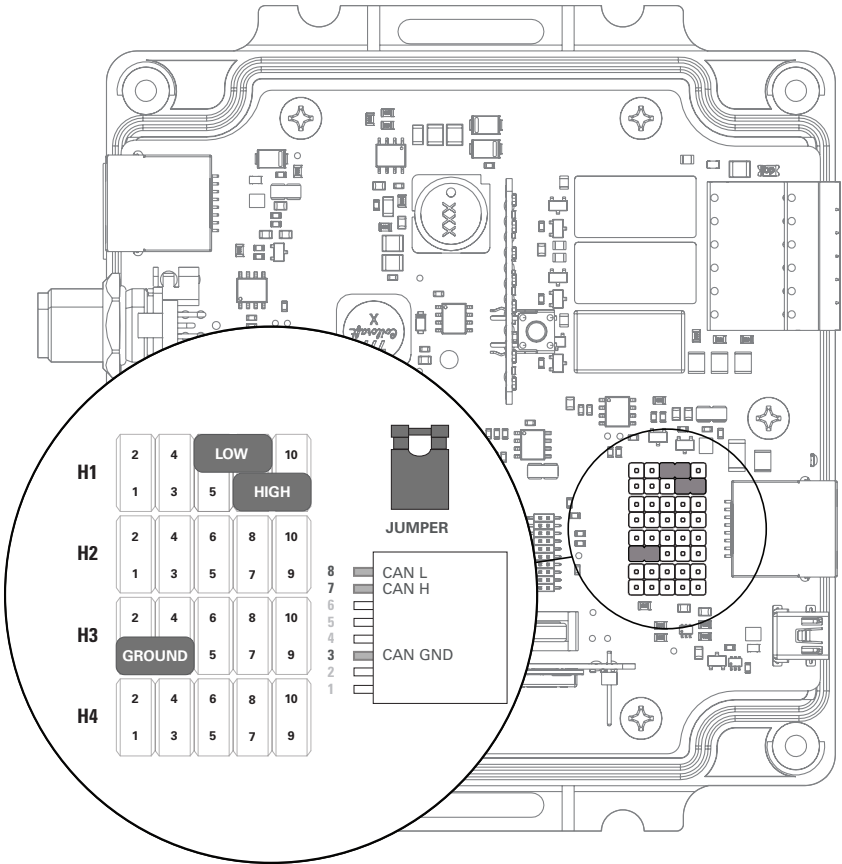

Figure 9. Victron Energy and Studer Innotec pin assignments

Schneider Electric - Xanbus Devices

CAN Out	Header Jumper	RJ45 Pin
CAN L	H3 - 6-8	4
CAN H	H2 - 7-9	5
CAN GND	H2 - 2-4	6

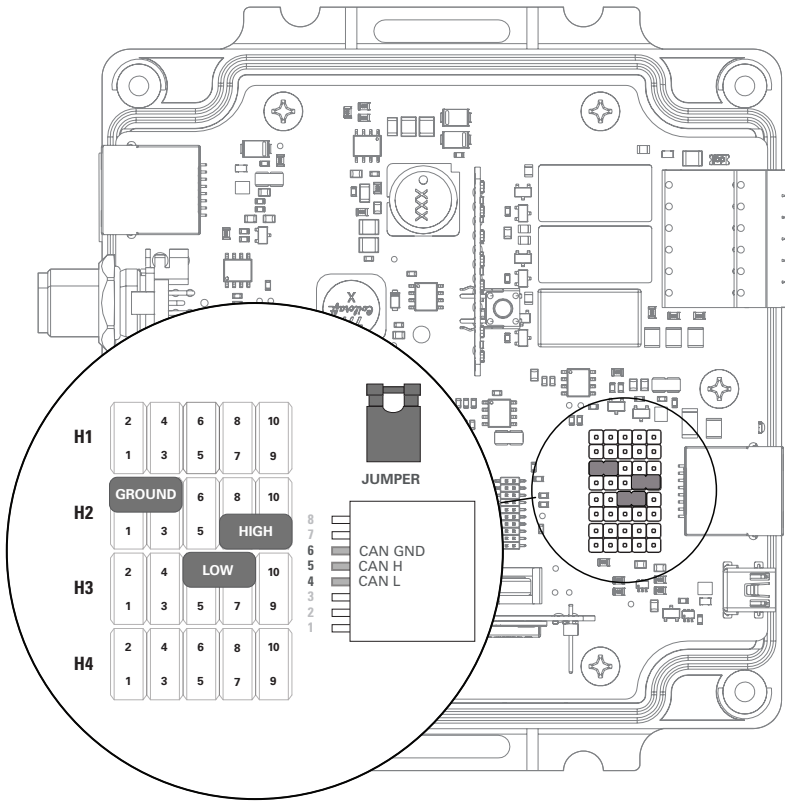

Figure 10. Schneider Electric Xanbus pin assignments

⚠ CAUTION

HAZARD OF EQUIPMENT DAMAGE

Pins 1, 2, and 7 are used by the Xanbus network to supply power to Xanbus-enabled devices on the network. Connect cables from the Xanbus port only with other Xanbus ports. Do not connect Xanbus to a LAN, CAN, or other type of port.

Failure to follow these instructions may result in equipment damage.

SMA - Sunny Island 4.4M, 6.0H, 8.0H, 4548-US, 6048-US

Sol-Ark - 8K Hybrid Indoor (Legacy), 12K Hybrid Indoor (Legacy)

Morningstar - GenStar MPPT Controller

CAN Out	Header Jumper	RJ45 Pin
CAN L	H2 - 5-7	5
CAN H	H3 - 8-10	4
CAN GND	H4 - 2-4	2

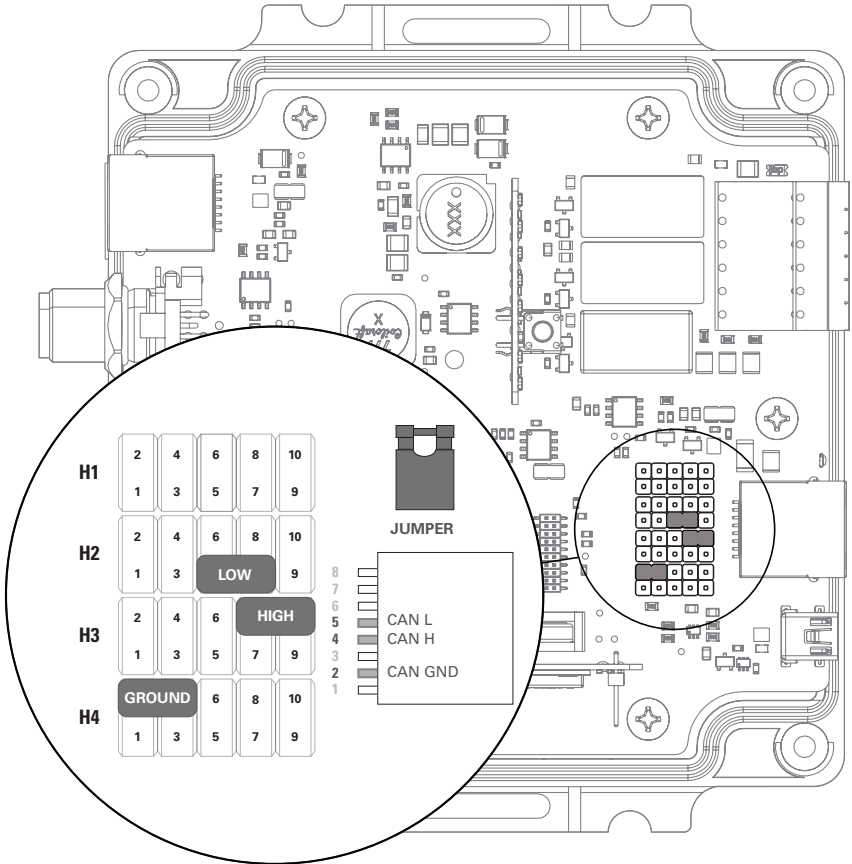

Figure 11. SMA, Sol-Ark, and Morningstar pin assignments

Sol-Ark 5K-P / 8K-P / 12K-P / 15K-P (Outdoor)

CAN Out	Header Jumper	RJ45 Pin
CAN L	H2 - 5-7	5
CAN H	H3 - 8-10	4
CAN GND	H2 - 2-4	6

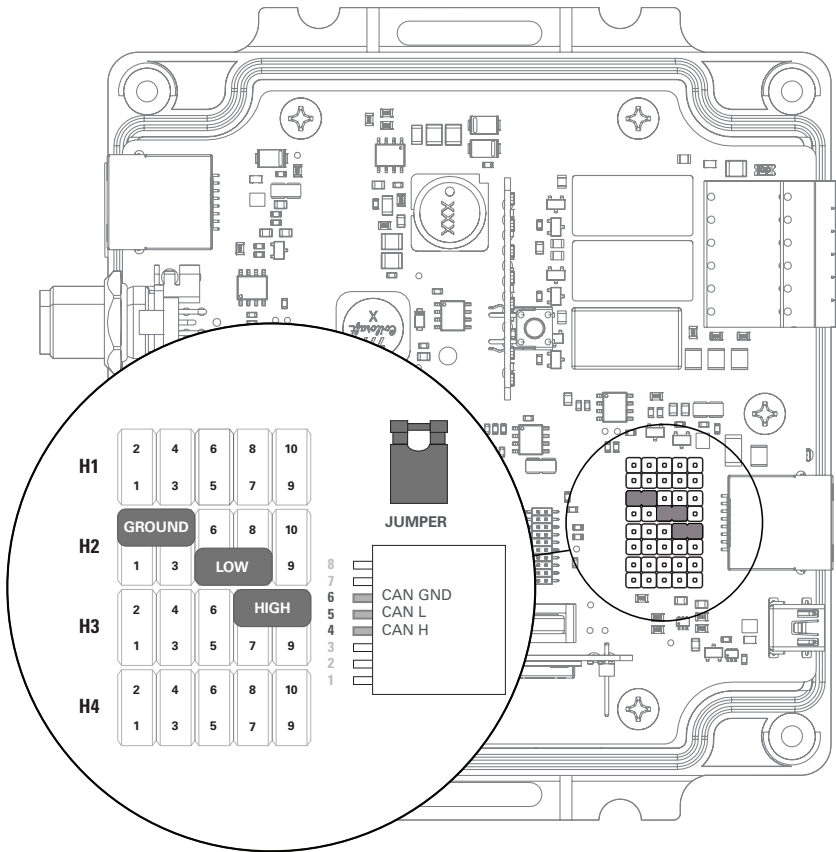

Figure 12. Sol-Ark Outdoor pin assignments

NOARK: 3K - 8K single-phase and 5K - 12K three-phase low-voltage Hybrid Inverters

SUNSYNK: 3K - 16K single-phase and 8K - 12K three-phase low-voltage Hybrid Inverters

CAN Out	Header Jumper	RJ45 Pin
CAN L	H2 - 5-7	5
CAN H	H3 - 8-10	4
CAN GND	N/A	N/A

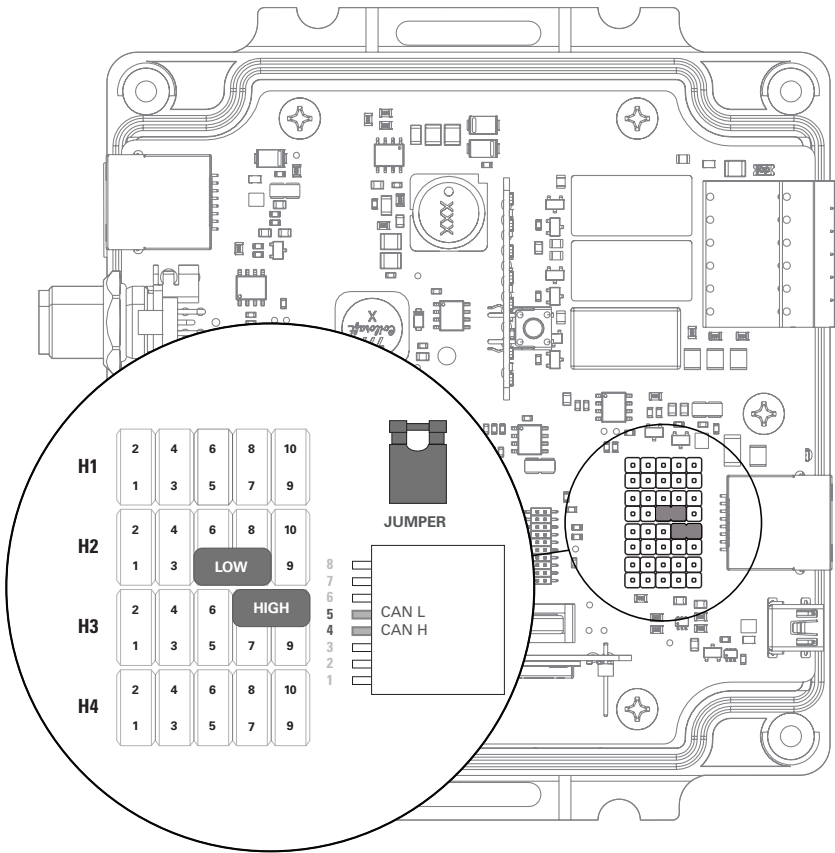

Figure 13. NOARK and SUNSYNK CAN pin assignments

7.0 INSTALLATION

Choose a clean, dry, easily accessible indoor location. All the communication ports on the LYNK II are accessible when mounted on a wall. Clearance of at least 100 mm (4 inches) from the connection points on the device is needed to allow for the bend radius of connected cables.

7.1 Mounting LYNK II

Screws or bolts can be threaded through the integrated Mounting Slots ([Figure 1](#), #12) to affix LYNK II to a flat surface. Mounting screws, bolts and nuts are not included. Threading straps through the integrated Hold Down Points ([Figure 1](#), #11) can be used to secure LYNK II to an object. Secure all cables to prevent them from working loose or becoming damaged.

7.2 Installing the External Power Source

LYNK II can utilize one of three power sources. LYNK II will automatically use the highest priority source if all three power sources are connected.

Connect LYNK II to one or more of the following:

- A 13-92 VDC power supply (or battery) connected to the Phoenix connector pin 7 (GND) and pin 9 (Vin).
- The AEBus Port or LYNK Port of a Discover lithium battery.
- A USB device (relays will not function with USB as the only power supply).

7.3 LYNK Network Communication Cables

CAUTION

HAZARD OF EQUIPMENT DAMAGE

- Do not connect a cable from an AEBus Port or LYNK Port to a WAN or MODEM Ethernet port.
- Turn OFF all devices before connecting cables.
- Mixing the LYNK Network with other networks may result in equipment malfunction and damage.

Failure to follow these instructions may result in equipment damage.

Networking Guidelines

- Separate data and power cables allow for separation between data and power cables. Avoid interference and data corruption caused by running network cables bundled with power cables.
- Allow for LYNK Network cable slack. Ensure that LYNK Network cables are slack and not in tension.
- Isolate the LYNK Network. Do not mix other networks with the LYNK Network.

NOTE

The LYNK II Communication Gateway is internally terminated. A termination resistor is not required.

LYNK (AEBus) Network Installation and Layout for AES LiFePO₄ batteries: 42-48-6650

Insert one end of a CAT5e or higher cable into the LYNK Port (RJ45) on the LYNK II. Insert the other end of the cable into the AEBus Port located on the AES LiFePO₄ battery. If there are multiple AES LiFePO₄ batteries, series network (daisy-chain) them together and insert the end of the cable from LYNK II into the AEBus Y-Connector at the end of the network, as shown in [Figure 14](#). The LYNK II Communication Gateway is terminated internally. Termination at the opposite end of the LYNK (AEBus) network is also required.

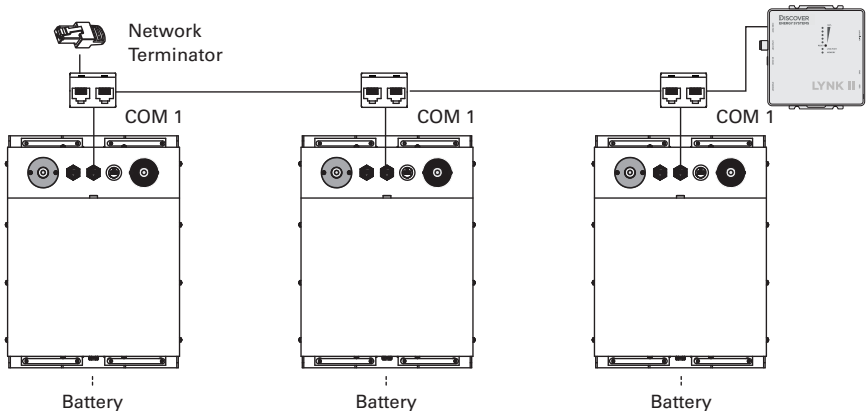

Figure 14. LYNK Network Installation and layout

LYNK (AEBus) Network Installation and Layout for AES LiFePO₄ batteries: 14-36-3000, 14-48-3000, 44-48-3000

Insert one end of a CAT5e or higher cable into the LYNK Port (RJ45) on the LYNK II. Insert the other end of the cable into the AEBus Port located on the AES LiFePO₄ battery. If there are multiple AES LiFePO₄ batteries, network them together in a daisy chain. Connect the cable from LYNK II to the AEBus Port of the battery at the end of the network, as shown in [Figure 15](#). The LYNK II Communication Gateway is terminated internally. Termination at the opposite end of the LYNK (AEBus) network is also required.

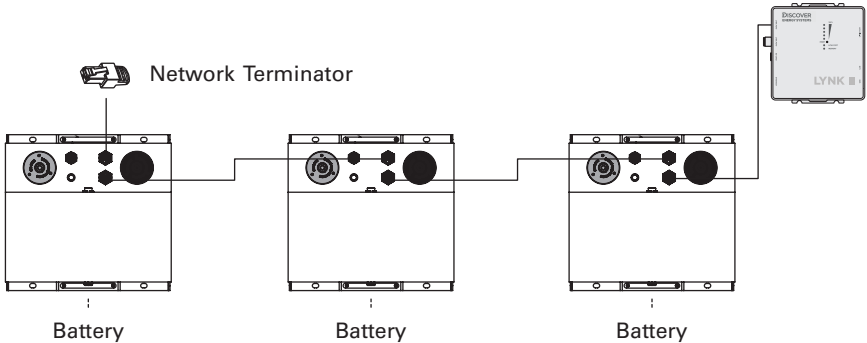

Figure 15. LYNK Network Installation and layout for AES 3K models

LYNK Network Installation and Layout for AES PROFESSIONAL batteries

1. Mount the devices according to their installation instructions before beginning network installations.
2. Attach the 950-0038 DLPT Connector to the LYNK Port on each battery ([Figure 16](#)). Ensure that the mating connectors are securely fastened.
3. Insert the male end of the cable into the female end of the 950-0038 DLPT Connector and vice versa.
4. Repeat until all batteries have been attached in a series network ([Figure 17](#)).
5. Attach one end of the series network to the LYNK Port on LYNK II. Termination of the other end is not required.

LYNK Network Cables Available for AES PROFESSIONAL Batteries	Part Number
DLP B2B-400 (COMM Cable 0.4 m)	950-0035
DLPTOL-7600 (COMM Cable 7.6 m)	950-0037
DLPTOL-1800 (COMM Cable 1.8 m)	950-0036
DLPT Connector (COMMT Connector) with DLP B2B-400 (COMM Cable 0.4 m)	950-0038
DLPT Connector (COMMT Connector)	950-0041

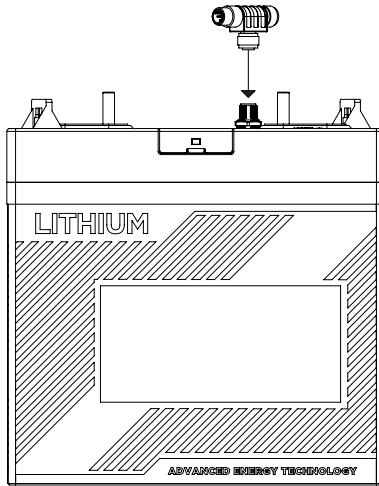

Figure 16. Attaching DLPT Connector to LYNK Port

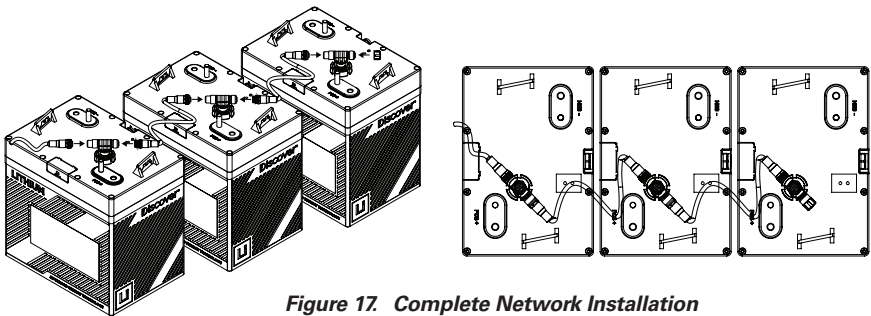

Figure 17. Complete Network Installation

LYNK Network Installation and Layout for AES RACKMOUNT batteries

Using a CAT5e or higher cable, insert one end into the LYNK Port (RJ45) on the LYNK II. Insert the other end of the cable into the LYNK Port located on the AES RACKMOUNT battery. If there are multiple AES RACKMOUNT batteries, insert CAT5e or higher cables to daisy-chain the batteries together. No extra termination is required as the LYNK II Communication Gateway and AES RACKMOUNT batteries are terminated internally.

1. Mount the devices according to their installation instructions before beginning network installations.
2. Attach CAT5e or higher cables to the LYNK Port, from one battery to the next battery, until all the batteries are connected to form a series network ([Figure 18](#)).
3. If you are using the Battery Module Combiner, also attach a CAT5e or higher cable from one of the batteries to the LYNK Port on the Battery Module Combiner.
4. At the end of the network, attach a CAT5e or higher cable from either the battery or the Battery Module Combiner to the LYNK Port on the LYNK II.

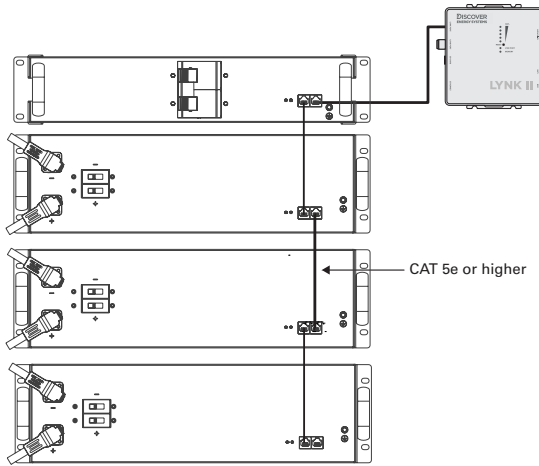

Figure 18. LYNK Network Installation for AES RACKMOUNT

7.4 Maximum Number of Batteries on the LYNK Network

The maximum number of batteries that can be connected together on a LYNK network varies between battery models.

Battery Name	Battery Model	Maximum Number of Batteries on LYNK Network ⁽¹⁾⁽²⁾
AES LiFePO ₄ Mobile	14-48-3000 14-36-3000	20
AES LiFePO ₄ Solar	42-48-6650 44-48-3000	20
AES PROFESSIONAL	DLP-GC2-48V DLP-GC2-36V DLP-GC2-24V DLP-GC2-12V	20
AES RACKMOUNT	48-48-5120	32
	48-48-5120-H	33 - 36 ⁽³⁾

⁽¹⁾ Only one LYNK II Communication Gateway is required on a LYNK network, which can include multiple collections of batteries either in enclosures or other battery storage systems connected in parallel.

⁽²⁾ The total length of the LYNK network cables must not exceed 36 m (118.11 ft).

⁽³⁾ To connect 33 to 36 batteries, remove the termination jumper from the AEBusTermination Header Board (refer to #1 in [Figure 6](#)). Keep the termination jumper in a safe place.

7.5 Verification of the LYNK Network

Verify the LYNK Network is complete using LYNK II.

- An illuminated LYNK Port LED confirms that communications are active for the LYNK Network.
- LYNK ACCESS software can be used via a computer to confirm the number of batteries on the LYNK Network.

8.0 RELAY HARDWARE INSTALLATION

NOTICE

HAZARD OF EQUIPMENT DAMAGE

Protect the relay contacts from overcurrent conditions with an external fuse.

Failure to follow these instructions may result in equipment damage.

See the 12-pin Connector Layout table and [Figure 19](#) below for the locations of pins on the Phoenix connector. Insert the connector wire into the correct pin hole. From the top of the connector pin hole, use a jeweler's flathead screwdriver to compress the screw and secure the wire. Refer to section [13.0](#) for information on configuring the relays. The LYNK II relays are disabled by default.

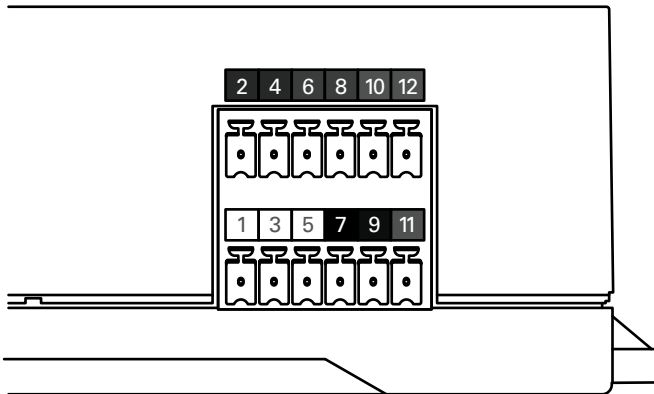
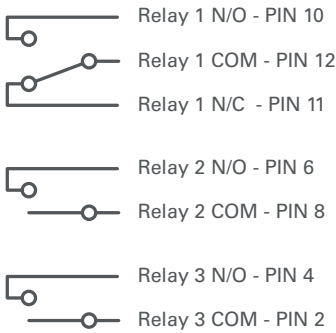

Figure 19. Pin Assignments for Phoenix 12-pin Connector

12-Pin Connector Layout					
2	4	6	8	10	12
RELAY 3 COM	RELAY 3 N/O	RELAY 2 N/O	RELAY 2 COM	RELAY 1 N/O	RELAY 1 COM
1	3	5	7	9	11
CAN HIGH	CAN LOW	CAN GND	POWER GND	POWER Vin (13-90V)	RELAY 1 N/C



Relay	Output Characteristics
Relay 1	N/O 0-30 VDC, maximum 5 A N/O 0-250 VAC, maximum 5 A N/C 0-30 VDC, maximum 5 A N/C 0-250 VAC, maximum 3 A
Relay 2	0-30 VDC, maximum 5 A 0-250 VAC, maximum 5 A
Relay 3	0-30 VDC, maximum 5 A 0-250 VAC, maximum 5 A

NOTE

The top and bottom Phoenix connectors can be removed by pulling them out of their socket. Reinstall in the same socket.

9.0 ETHERNET HARDWARE INSTALLATION AND LAYOUT

NOTICE

HAZARD OF EQUIPMENT DAMAGE

Do not plug a CANbus Terminator into the Ethernet Port of an LYNK II Gateway Device.

Failure to follow these instructions may result in equipment damage.

Ethernet is disabled and reserved for future functionality.

10.0 CONNECTING TO LYNK ACCESS

LYNK ACCESS software for 64-bit Windows 10 / 11 is required to configure LYNK II devices for CAN communication with compatible external devices such as inverters, chargers, and motor controllers.

1. Download the current version of LYNK ACCESS software from the Discover Energy Systems website to obtain the most up-to-date suite of available device configurations.
2. Using a USB cable with a Type-B mini plug, connect the 64-bit Windows 10 / 11 device running LYNK ACCESS software to the USB port on LYNK II.

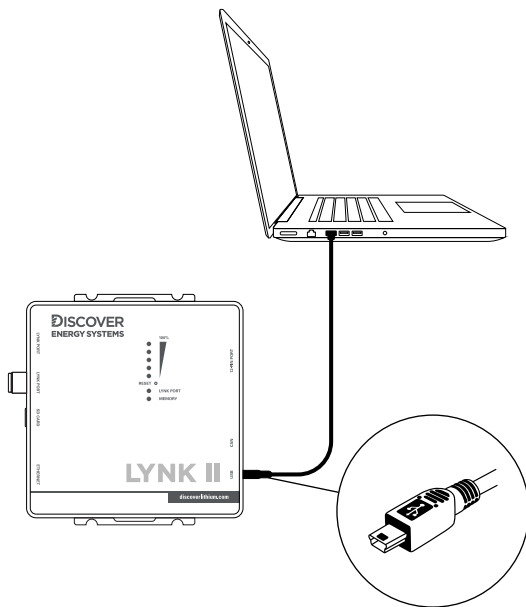

Figure 20. LYNK II USB Type-B Mini connection

NOTE

A powered USB hub may be required as a source of power to operate LYNK II.

3. Start the LYNK ACCESS software program. LYNK II configurations and settings are found by selecting the LYNK tab.

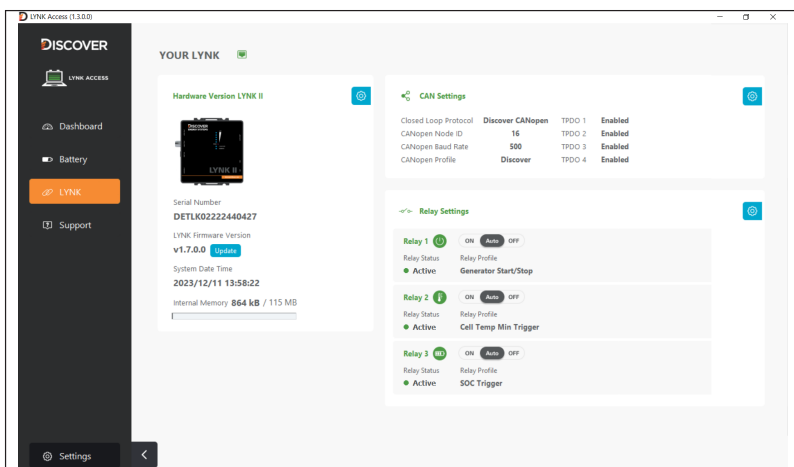

Figure 21. LYNK II configuration and settings screen

11.0 CONFIGURING THE CAN COMMUNICATION WITH LYNK ACCESS

1. Connect the LYNK II to a PC with LYNK ACCESS software installed. Ensure that you only have one LYNK device connected to the Computer.
2. Start the LYNK ACCESS software and select the LYNK tab.
3. Select the blue gear icon in the upper right area of the CAN Settings tile.
4. Select one of the pre-configured Closed-Loop Protocols to complete the configuration.
5. Click SAVE to confirm the configuration.

Refer to the appropriate application note for instructions on setting the external device to communicate correctly with LYNK II. The Discover Energy Systems website has up-to-date application notes for various external devices.

NOTICE

HAZARD OF EQUIPMENT DAMAGE

Saving configuration changes using LYNK ACCESS will automatically restart LYNK II and cause communications with other devices to be interrupted.

Failure to follow these instructions may result in equipment damage.

12.0 CONFIGURING ETHERNET SETTINGS WITH LYNK ACCESS

Reserved for future functionality.

13.0 CONFIGURING RELAYS WITH LYNK ACCESS

Configuration of the LYNK II relays should only be done by qualified personnel.

1. Start the LYNK ACCESS software and select the LYNK tab.
2. Select the blue gear icon in the upper right area of the Relay Settings tile.
3. From the Relay list, select the relay to configure.
4. From the Relay Profile list, select one of the pre-configured profiles and follow on-screen prompts to complete the configuration.
5. Click SAVE to confirm the configuration.

The LYNK II relays can be forced ON or OFF from within LYNK ACCESS to confirm the operation. Use LYNK ACCESS to clear the relay state.

NOTICE

HAZARD OF UNEXPECTED EQUIPMENT OPERATION AND DAMAGE

Unexpected equipment activity may occur while programming the relays. Disconnect all devices by removing the Phoenix connector from LYNK II. Replace the Phoenix connector when programming is complete.

Failure to follow these instructions may result in equipment damage.

NOTE

- By default, the relays are disabled.
- Saving the relay settings will automatically restart LYNK II.
- A relay that has been forced ON or OFF will remain in the selected state even after a power reset. Use LYNK ACCESS to clear a relay.
- If the time changes as a result of daylight saving time, review and reset all time-based triggers at the changeover date.
- For more information about using relays, refer to the [LYNK II Relay Guide Reference Manual](#) (805-0069).

13.1 Relay Configuration - Relay Profile

Relay Profile	Description
Disable Relay	The relay is not configured.
Generator Start/Stop	Activate the relay based on the State of Charge of the Discover Lithium battery system. This profile includes generator specific settings: Max Run Time , Quiet Time , and Exercise Generator .
Cell Temp Min Trigger	Activate the relay based on the lowest internal cell temperature in the Discover Lithium battery system. This relay profile is commonly used for activating heating HVAC systems. Valid trigger threshold: -20 to 55 °C (-4 to 131 °F)
Cell Temp Max Trigger	Activate the relay based on the highest internal cell temperature in the Discover Lithium battery system. This relay profile is commonly used for activating cooling HVAC systems. Valid trigger threshold: -20 to 55 °C (-4 to 131 °F)

Relay Profile	Description
Cell Voltage Min Trigger	Activate the relay based on the lowest cell voltage in the Discover Lithium battery system. This trigger source is commonly used for load shedding as the battery system reaches low voltage. Valid trigger threshold: 2000 mV - 3650 mV
Cell Voltage Avg Trigger	Activate the relay based on the average cell voltage of the Discover Lithium battery system. Valid trigger threshold: 2000 mV - 3650 mV
Cell Voltage Max Trigger	Activate the relay based on the highest cell voltage in the Discover Lithium battery system. Valid trigger threshold: 2000 mV - 3650 mV
Current Trigger	Activate the relay based on the aggregate DC Current of the Discover Lithium battery system. Valid trigger threshold: -5000 A to 5000 A
SOC Trigger	Activate the relay based on the State of Charge of the Discover Lithium battery system. Valid trigger threshold: 1% - 99%
Alarm Trigger	Activate the relay based on alarm conditions. Choose whether the relay is activated when ANY of the enabled alarms occur, or when ALL the enabled alarms occur. For descriptions of each alarm, refer to 13.3 Relay Configuration - Alarm Trigger . You can also differentiate whether each alarm is triggered on warning or fault. Warning: Alarm is triggered on entering the fault condition but before the battery faults. Fault: Alarm is triggered when the battery faults.

13.2 Relay Configuration - Trigger Settings

Trigger/Feature	Description
Trigger (Source)	Selects the trigger that activates the relay: SOC, battery cell voltage, battery cell temperature, current, or alarms.
Trigger - Activated Threshold	Sets the voltage, temperature, SOC, or current threshold that activates the relay.

Trigger/Feature	Description
Trigger - Activated Delay	Sets a delay period between when the trigger source reaches the activation threshold and when the relay is activated.
Trigger - Deactivated Threshold	Sets the voltage, temperature, SOC, or current threshold that deactivates the relay.
Trigger - Deactivated Delay	Sets a delay period between when the trigger source reaches the deactivation threshold and when the relay is deactivated.
Trigger Direction (<)	Sets the trigger to activate or deactivate the relay when the Trigger Source is less than the defined threshold value.
Trigger Direction (>)	Sets the trigger to activate or deactivate the relay when the Trigger Source is greater than the defined threshold value.
Max RunTime	<p>Only available with Generator start/stop. Sets the maximum time that a relay can remain activated after being triggered. Independent of QuietTime or ExerciseTime.</p> <p>At the end of the Max Run Time, if the trigger value is still below the threshold, the relay will be re-triggered.</p>
QuietTime (Scheduled Off)	<p>Only available with Generator start/stop. The relay will not activate ON during the programmed period.</p> <p>This feature is overridden when the relay is Forced ON or Forced OFF.</p>
Exercise Generator (Scheduled On)	<p>Only available with Generator start/stop. The relay will activate ON and OFF based on the programmed period, regardless of other values and thresholds.</p> <p>This feature is overridden when the relay is Forced On or Forced Off.</p>

13.3 Relay Configuration - Alarm Trigger

Alarm	Description
Low Voltage	Battery cell low-voltage warning or fault.
High Voltage	Battery cell high-voltage warning or fault.

Alarm	Description
High Charge Current	High charge current warning or fault.
High Discharge Current	High discharge current warning or fault.
LowTemp Charge	Battery temperature too low to charge warning or fault.
LowTemp Discharge	Battery temperature too low to discharge warning or fault.
High Temp Charge/ Discharge	Battery temperature too high to charge/discharge warning or fault.
High Board/RelayTemp	High temperature on the board/relay warning or fault.
Hardware Diagnostics	Battery Management System hardware fault.
Breaker Open (AES RACKMOUNT)	Breaker is open on the battery.

13.4 Relay Configuration - Operation States

Once configured, the relay will operate in 1 of 3 states: Auto, Forced ON, or Forced OFF.

Auto	Automatically activates and deactivates the relay-based the user-configured logic.
Forced ON	Immediately activates and holds the relay in the activated state. This state is not cleared during a power reset.
Forced OFF	Immediately deactivates and holds the relay in the inactivated state. This state not is cleared during a power reset.

NOTE

A relay that has been forced ON or OFF will remain in the selected state even after a power reset. Use LYNK ACCESS to clear a relay.

14.0 TROUBLESHOOTING THE BATTERY WITH LYNK ACCESS

If you encounter problems with a Discover Lithium battery, contact a Discover Service/Support team member. You may be asked to use the LYNK ACCESS software to provide battery data or reports.

14.1 Generating a Battery Diagnostic Report

1. Connect the battery communication cable to the LYNK Port on the LYNK II and to the LYNK Port/AEbus Port on one of the batteries in the battery bank.
 - AES LiFePO₄ and AES RACKMOUNT batteries connect a CAT5e or higher cable.
 - AES PROFESSIONAL batteries connect a DLP communication cable.
2. Connect a USB cable with a mini-B connector from your computer to the LYNK II. Ensure that you only have one LYNK device connected to the computer.
3. Start the LYNK ACCESS software and select the Support tab.
4. Click the Generate Diagnostic Report button and from the displayed dialog box, select the download parameters.

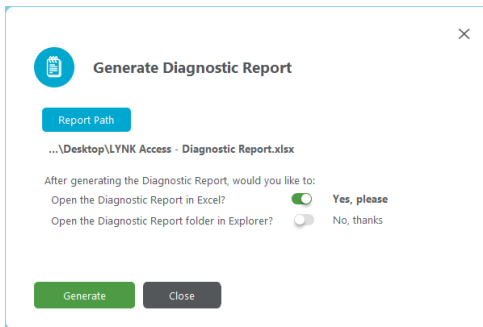

Figure 22. Generate Diagnostic Report dialog box

5. Click Generate and share the report with the Discover Service/Support team member.

14.2 Exporting Battery Data Logs

The BMS on a Discover Lithium battery records changes to the battery over its lifetime, including the battery SOC, cell voltage, temperature, and charge/discharge. This information is helpful in optimizing and troubleshooting the battery and power conversion system and is often requested by the Service/Support team when analyzing issues with a battery.

When using AES RACKMOUNT or AES PROFESSIONAL batteries, use the LYNK II and corresponding LYNK ACCESS software to download the battery data logs. When using AES LiFePO₄ batteries, use the AES Dashboard software to download the battery data logs.

The following describes the export process using LYNK II and LYNK ACCESS.

1. Connect the battery communication cable to the LYNK Port on the LYNK II and to the LYNK Port on one of the batteries in the battery bank.
 - AES RACKMOUNT batteries connect a CAT5e or higher cable.
 - AES PROFESSIONAL batteries connect a DLP communication cable.
2. Connect a USB cable with a mini-B connector from your computer to the LYNK II. Ensure that you only have one LYNK device connected to the computer.
3. Start the LYNK ACCESS software and select the Battery tab.
4. To synchronize the data logs on the LYNK II with the data logs on the battery, right-click the Download All Data Logs button and from the popup menu, select Update Data Log Cache.

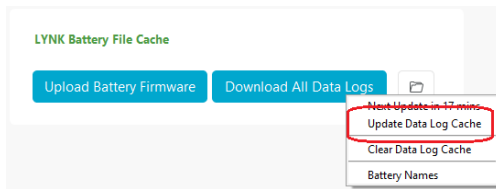

Figure 23. Update Data Log Cache

Wait a few minutes to allow for data transfer.

5. Left-click the Download All Data Logs button and from the displayed dialog box, select the download parameters.

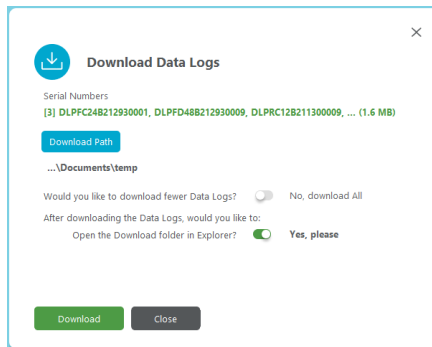

Figure 24. Download Data Logs dialog box

- Click Download.
- Each battery exports a single CSV file. Open the file in a spreadsheet application to view the data.

File v2.1	FW v4.6.0.0	BMS Gen-4	SN DLPFD48B212930009																	
Time	SOC (%)	Fault Status	Relay On	High Cell Voltage (V)	Low Cell Voltage (V)	Average Cell Voltage (V)	Delta Cell Voltage (V)	Terminal Voltage (V)	Average Current (A)	RMS Current (A)	Cell Block Temperature (C)	Heater On	High Cell Number	Low Cell Number	Power Up	Power Down	Balancing			
1/3/2024 10:27	99		1	3.33	3.33	3.33	0	53.3	0	0	22	0	14	10	1	0	0	0	0	
1/3/2024 10:27	99		1	3.33	3.33	3.33	0	53.2	0	0	22	0	3	1	0	0	0	0	0	
1/3/2024 10:27	99		1	3.33	3.33	3.33	0	53.1	0	0	22	0	3	1	0	0	0	0	0	
1/3/2024 10:27	99		1	3.33	3.33	3.33	0	53.3	0	0	22	0	4	1	0	0	0	0	0	
1/3/2024 10:27	99		1	3.33	3.33	3.33	0	53.4	0	0	22	0	5	1	0	0	0	0	0	
1/3/2024 10:27	99		1	3.33	3.33	3.33	0	53.3	0	0	22	0	4	1	0	0	0	0	0	
1/3/2024 10:27	99		1	3.33	3.33	3.33	0	53.4	0	0	22	0	8	1	0	0	0	0	0	
1/3/2024 10:27	99		1	3.33	3.33	3.33	0	53.3	0	0	22	0	4	1	0	0	0	0	0	
1/3/2024 10:28	99		1	3.33	3.33	3.33	0	53.3	0	0	22	0	4	1	0	0	0	0	0	
1/3/2024 10:28	99		1	3.33	3.33	3.33	0	53.3	0	0	22	0	8	1	0	0	0	0	0	

Figure 25. Example Battery Data Log

NOTE

If the LYNK II has been connected to other batteries, it may still store log files for those other batteries. To remove unnecessary battery logs, use the Clear Data Log Cache command in step 4.

15.0 UPDATING LYNK II FIRMWARE WITH LYNK ACCESS

- Open LYNK ACCESS and select the LYNK tab.

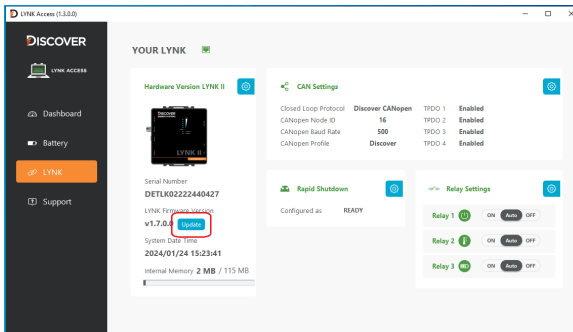

Figure 26. LYNK Access - Update Firmware

- Select the Firmware Version update button and follow the on-screen prompts to complete the update process.
- Click SAVE to confirm the configuration.

NOTE

Downloading the latest firmware file from the Discover Energy Systems website may be required. (<https://www.discoverlithium.com>)

16.0 LYNK II SPECIFICATIONS

Specification	Description
Device	LYNK II Communication Gateway
Part Number	950-0025
L x W x H	120 x 135 x 44 mm (4.7 x 5.4 x 1.7 in)
Weight	0.3 kg (0.7 lb)
IP Rating	IP20 (Indoor Use Only)
Operating Temperature	-20 to 50°C (-4 to 122°F)
Storage Temperature	-40 to 85°C (-40 to 185°F)
Operating Humidity	< 95%, Non-condensing
Storage Humidity	< 95%, Non-condensing
Mounting	Built-in Surface Mount Bracket
Marking	CE